

# **OPERATIONALLY EFFICIENT PROPULSION SYSTEM STUDY (OEPSS) DATA BOOK**

**Volume IV - OEPSS Design Concepts**

**April 24, 1990**

**Prepared for  
Kennedy Space Center  
NAS10-11568**

**Prepared by  
George S. Wong  
James M. Ziese  
Shahram Farhangi**

**Rocketdyne Study Managers: G. S. Wong/G. S. Waldrop  
NASA, KSC Study Manager: R. E. Rhodes**

**Rocketdyne Division  
Rockwell International  
6633 Canoga Avenue  
Canoga Park, CA 91303**

(NASA-CR-188752) OPERATIONALLY EFFICIENT  
PROPULSION SYSTEM STUDY (OEPSS) DATA BOOK.  
VOLUME 4: OEPSS DESIGN CONCEPTS Final  
Report, 24 Apr. 1989 - 24 Apr. 1990  
(Rockwell International Corp.) 95 pCSCL 148 G3/14

N92-20266

Unclas  
0036876

## Report Documentation Page

1. Report No.	2. Government Accession No.	3. Recipient's Catalog No.	
4. Title and Subtitle <b>Operationally Efficient Propulsion System Study (OEPSS) - Data Book; Volume 4 of 5, OEPSS Design Concepts</b>		5. Report Date	
		6. Performing Organization Code	
7. Author(s) <b>George S. Wong, James M. Ziese, and Shahram Farhangi</b>		8. Performing Organization Report No. <b>RI/RD 90-149-4</b>	
		10. Work Unit No.	
9. Performing Organization Name and Address <b>Rocketdyne Division, Rockwell International Corporation 6633 Canoga Ave. Canoga Park, CA 91303</b>		11. Contract or Grant No. <b>NAS10-11568</b>	
		13. Type of Report and Period Covered <b>Interim Report; April 1989-April 1990</b>	
12. Sponsoring Agency Name and Address <b>National Aeronautics and Space Administration, John F. Kennedy Space Center, Kennedy Space Center, Florida 32899</b>		14. Sponsoring Agency Code	
		15. Supplementary Notes <b>Study conducted under ALS/ADP5103 Contract Technical Monitor: Russel E. Rhodes Co-author Organizations: Raymond J. Byrd, Boeing Aerospace Operations; James M. Ziese, Space Systems Division, Rockwell International</b>	
16. Abstract <b>This study was initiated to identify operations problems and cost drivers for current propulsion systems and to identify technology and design approaches to increase the operational efficiency and reduce operations costs for future propulsion systems. To provide readily usable data for the ALS program, the results of the OEPSS study have been organized into a series of OEPSS Data Books as follows: Volume I, Generic Ground Operations Data Volume II, Ground Operations Problems; Volume III, Operations Technology; Volume IV, OEPSS Design Concepts; and Volume V, OEPSS Final Review Briefing, which summarizes the activities and results of the study. This volume describes three propulsion concepts that will simplify the propulsion system design and significantly reduce operational requirements. The concepts include: (1) a fully-integrated, booster propulsion module concept for the ALS that avoids the complex system created by using autonomous engines with numerous artificial interfaces; (2) an LOX tank aft concept which avoids potentially dangerous geysering in long LOX propellant lines; and (3) an air-augmented, rocket engine nozzle afterburning propulsion concept that will significantly reduce LOX propellant requirements, reduce vehicle size and simplify ground operations and ground support equipment and facilities.</b>			
17. Key Words (Suggested by Author(s)) <b>Launch operations, propulsion module, propulsion system, propellant tanks, LOX/LH2 systems, air augmented rocket, operability, ejector /rocket, integrated design</b>		18. Distribution Statement <b>Unclassified -- unlimited</b>	
19. Security Classif. (of this report) <b>Unclassified</b>	20. Security Classif. (of this page) <b>Unclassified</b>	21. No. of pages <b>49</b>	22. Price

# **OPERATIONALLY EFFICIENT PROPULSION SYSTEM STUDY (OEPSS) DATA BOOK**

**Volume IV - OEPSS Design Concepts**

**April 24, 1990**

**Prepared for  
Kennedy Space Center  
NAS10-11568**

**Prepared by  
George S. Wong  
James M. Ziese  
Shahram Farhangi**

**Rocketdyne Study Managers: G. S. Wong/G. S. Waldrop  
NASA, KSC Study Manager: R. E. Rhodes**

**Rocketdyne Division  
Rockwell International  
6633 Canoga Avenue  
Canoga Park, CA 91303**



## **FOREWORD**

This document is part of the final report for the Operationally Efficient Propulsion System Study (OEPSS) conducted by Rocketdyne Division, Rockwell International for the AFSSD/NASA ALS Program. The study was conducted under NASA contract NAS10-11568 and the NASA Study Manager is Mr. R. E. Rhodes. Rocketdyne, supported by Rockwell's Space Systems Division, also initiated an independent IR&D study of an Integrated Booster Propulsion Module for the ALS which was deepened under the OEPSS study. The period of study was from 24 April 1989 to 24 April 1990.

## **ABSTRACT**

This study was initiated to identify operations problems and cost drivers for current propulsion systems and to identify technology and design approaches to increase the operational efficiency and reduce operations cost for future propulsion systems. To provide readily useable data for the ALS program, the results of the OEPSS study have been organized into a series of OEPSS Data Books as follows: Volume I, Generic Ground Operations Data; Volume II, Ground Operations Problems; Volume III, Operations Technology; and Volume IV, OEPSS Design Concepts. This volume describes how operations problems identified in Volume II can be avoided by proper propulsion system design. Design approaches to simplify system design and reduce operational complexity are suggested. The fact that operational efficiency must begin with initial design of the propulsion concept and must drive the concept is a point greatly emphasized. Study examples to illustrate operations-driven design approaches include the following propulsion concepts: (1) a fully integrated booster propulsion module (BPM) concept; (2) a LOX tank aft propulsion system concept; and (3) an air-augmented, rocket engine nozzle afterburning propulsion concept.

PRECEDING PAGE BLANK NOT FILMED

RI/RD90-149-4



## ACKNOWLEDGMENT

The authors wish to express their thanks to the following people for their contributions to the conceptual design studies reported in this databook: W. B. Ingle, W. L. Bigelow, P. S. Chen, W. H. Geniec, and V. R. Kemp from Rocketdyne and J. E. Frericks, S. R. Kent, and N. Elgabalawi from Rockwell's Space Systems Division, on the Integrated Propulsion Module Concept, and to R. A. O'Leary for providing technical guidance on the Air Augmented, Ejector/Rocket Concept.

PRECEDING PAGE BLANK NOT FILMED

RI/RD90-149-4





## INTRODUCTION

Today's propulsion systems are primarily performance-driven and, therefore, are sophisticated and complex, although highly successful in meeting performance. However, experience to date has shown that operational cost for these propulsion systems is exceedingly high and has become a large fraction of the vehicle recurring cost per flight, ranging from 20% to 40% for expendable and reusable launch vehicles, respectively (Ref. 1). This is shown in Figure 1. Not only has our complex design increased our operations cost, but it has also severely restricted our ability to achieve routine space flight because of time consuming launch processing and launch delays.

In view of current experience, it is abundantly clear that operational complexity stems first from design. In fact, operational analysis shows that design complexity is an "exponential" function of the number of parts and corresponding number of interfaces contained in the system. In order to reduce operations cost, a system must first be designed for operational simplicity. This means that in design the first step is to eliminate as many systems and components as possible. This is fundamentally important because each system and component must be inspected, serviced, maintained, and checked-out prior to flight. The elimination of one system (in a multiple unit system) will reduce time, manpower, and equipment required for launch processing and will eliminate many ground support operations and facilities as well. Therefore, in order to achieve operational efficiency and low operations cost, operational simplicity of a propulsion design must start with the beginning concept of the propulsion design. This approach is illustrated in Figure 2. System operability is like product quality - you can no more inspect quality into the design or achieve operability in a system unless you "design" quality and operability into the product or system from the very "beginning."

In this databook, propulsion design concepts are used to illustrate how operational efficiency is achieved by applying "lessons learned" from launch experience. This is done by taking the operations problems, or concerns, identified by the OEPSS study and see how these problems can be eliminated or mitigated by simplifying the design concept to minimize operations without compromising its primary function. The purpose of these illustrations is to demonstrate the many potential ways to conceive a propulsion design that will achieve operational efficiency, improve reliability, and lower operations cost (without sacrificing performance) while providing the required thrust and control needed by the vehicle to achieve its mission. The approach to true operability is to treat the propellant tankage, fluid system, thrust chambers, turbopumps, controls, structure, and support systems all as part of an integral propulsion system rather than a grouping of highly individualized subsystems. This is the most promising way to eliminate unneeded duplicate parts and functions and unwarranted operational complexity and cost.

---

<sup>1</sup> "Reducing Launch Operations Cost," Technical Memorandum, Office of Technology Assessment, September 1988

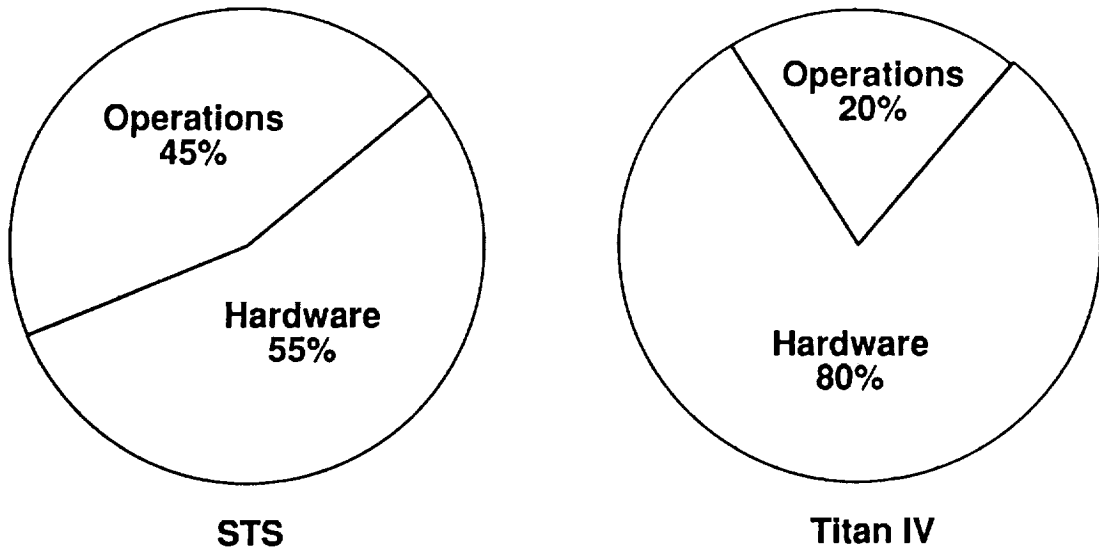

Figure 1. Launch Operations Cost per Flight

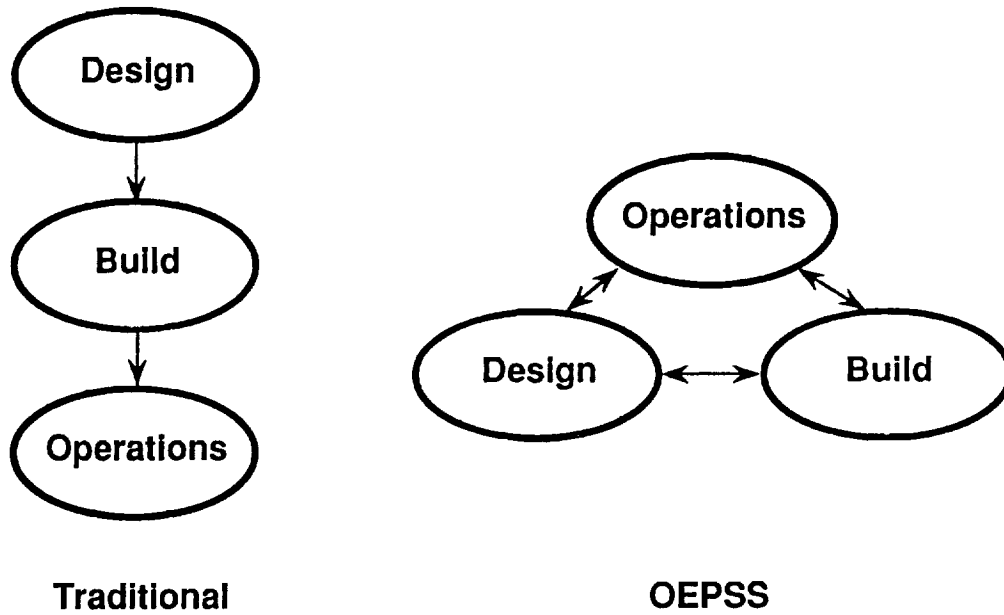

Figure 2. Engine Design and Development Cycle

# CONTENTS

1.0 FULLY INTEGRATED, BOOSTER PROPULSION MODULE (BPM) CONCEPT .....	1-1
1.1 GROUND OPERATIONS PROBLEMS .....	1-1
1.1.1 Closed Aft Compartments .....	1-1
1.1.2 Hydraulic System .....	1-1
1.1.3 Lack of Hardware Integration and Many Artificial Interfaces .....	1-2
1.2 OPERATIONALLY EFFICIENT PROPULSION SYSTEM .....	1-2
1.2.1 Conventional Propulsion Module .....	1-2
1.2.2 Operationally Efficient Propulsion Module .....	1-7
1.3 FULLY INTEGRATED BPM CONCEPTUAL DESIGN .....	1-15
1.3.1 Design Configuration .....	1-15
1.4 FULLY INTEGRATED BPM FUNCTIONAL OPERATION .....	1-20
1.4.1 System Flow-Balance for Integrated BPM .....	1-24
1.4.2 Component-Out Capability .....	1-29
1.4.3 System Start and Shutdown .....	1-32
1.4.4 Avionics System .....	1-33
1.5 THRUST VECTOR CONTROL .....	1-38
1.6 RELIABILITY, OPERABILITY, AND COST .....	1-39
1.6.1 Design Simplicity .....	1-39
1.6.2 Comparative Reliability .....	1-46
1.6.3 Comparative System Cost .....	1-46
1.6.4 Comparative System Weight .....	1-49
1.7 OPERATIONS MUST DRIVE CONCEPTUAL DESIGN .....	1-49
1.8 PAYLOAD CAPABILITY OF AN INTEGRATED PROPULSION SYSTEM ..	1-52
2.0 LOX TANK AFT PROPULSION CONCEPT .....	2-1
2.1 TYPICAL PROPELLANT TANK CONFIGURATION .....	2-1
2.2 OPERATIONS PROBLEMS .....	2-1
2.2.1 Geysering .....	2-1
2.2.2 Propellant Conditioning .....	2-3
2.2.3 Checkout .....	2-3
2.2.4 Pogo .....	2-3
2.2.5 Facilities .....	2-4
2.3 ALTERNATE PROPELLANT TANK CONFIGURATIONS .....	2-4
2.3.1 LOX Tank Aft .....	2-4
2.3.2 Parallel Long tanks .....	2-6
2.3.3 Concentric Tanks .....	2-11

# CONTENTS

2.3.4	Toroidal LOX Tank .....	2-14
2.4	ALTERNATE TANK CONFIGURATION COMPARISON .....	2-16
2.4.1	Relative Weights .....	2-16
2.4.2	Relative Cost .....	2-17
2.5	VEHICLE CONTROL ASSESSMENT .....	2-17
2.5.1	Aerodynamic Disturbances .....	2-18
2.5.2	Thrust Misalignment .....	2-18
2.5.3	Asymmetric Engine Locations .....	2-18
2.5.4	Engine Failure .....	2-21
2.5.5	Results .....	2-21
3.0	AIR-AUGMENTED, ROCKET ENGINE NOZZLE AFTERBURNING PROPULSION CONCEPT .....	3-1
3.1	THRUST AUGMENTATION .....	3-2
3.1.1	Assumptions .....	3-3
3.1.2	Thrust Calculation .....	3-4
3.2	DESIGN ISSUES .....	3-4
3.2.1	Operating Flight Regime .....	3-5
3.2.2	Air Induction System .....	3-5
3.2.3	Mixing/Combustion .....	3-5
3.2.4	Drag .....	3-6
3.2.5	Boundary Layer Effects .....	3-6
3.2.6	Ejector Weight .....	3-6
3.2.7	Engine/Vehicle Integration .....	3-6
3.3	CURRENT EJECTOR/ROCKET STUDY .....	3-6

## TABLES

1-1.	Integrated Propulsion System Design Goals .....	1-16
1-2.	Specific Design Goals for Booster Propulsion Module .....	1-17
1-3.	Integrated BPM Design Data .....	1-27
1-4.	Component-Out Operating Conditions .....	1-31
1-5.	Turbopump Operating Speeds .....	1-32
1-6.	Integrated BPM System Features .....	1-36
1-7.	Integrated BPM Typical Electronic Controller Function .....	1-37
1-8.	Thrust Vector Control Options .....	1-38
1-9.	Booster Propulsion Module Hardware Comparison .....	1-45
1-10.	Booster Propulsion Module Reliability Comparison .....	1-47
1-11.	Booster Propulsion Module System Cost**Comparison .....	1-48
1-12.	Booster Propulsion Module System Weight Comparison .....	1-50
1-13.	Integrated Propulsion Module Has High Reliability and Operability and Low Operations Cost .....	1-51
1-14.	Payload Capability Using Integrated Engine Elements .....	1-52
2-1.	Relative Cost Ranking of Alternate Tank Configurations .....	2-17

## FIGURES

1-1.	Baseline LOX/LH2 ALS Vehicle .....	1-3
1-2.	Space Transportation Main Engine (STME) .....	1-4
1-3.	Conventional Booster Propulsion System .....	1-5
1-4.	Conventional Core Propulsion System .....	1-6
1-5.	Integrated Booster Propulsion Module - Engine .....	1-8
1-6.	Integrated Core Propulsion Module - Engine .....	1-9
1-7.	Integrated Propulsion Module - Engine Element .....	1-11
1-8.	Separate Engine Helium Supply Systems .....	1-12
1-9.	Integrated Engine Helium Supply System .....	1-13
1-10.	Booster Avionics/Control Schematic .....	1-14
1-11.	Integrated Booster Propulsion Module Fluid Schematic .....	1-18
1-12.	8/4 Booster-Core Configuration Achieves Maximum Commonality .....	1-21
1-13.	Integrated Booster Propulsion System Fluid Schematic .....	1-22
1-14.	Integrated Core Propulsion System Fluid Schematic .....	1-23
1-15.	Booster Propulsion System Flow Balance Schematic .....	1-24
1-16.	Integrated BPM Method of Analysis .....	1-25
1-17.	Integrated BPM Engine Balance .....	1-26
1-18.	LH2 Pump Performance Map .....	1-28

## FIGURES

1-19.	LOX Pump Performance Map .....	1-28
1-20.	Simplified Integrated System Schematic .....	1-30
1-21.	Turbopump Operating Margin .....	1-31
1-22.	Transient Model Primary Programming Modules .....	1-34
1-23.	Methodology for Transient Simulation Modeling .....	1-35
1-24.	Integrated BPM Avionics Definition .....	1-36
1-25.	Parameters for Typical ALS Trajectory .....	1-40
1-26.	Core TVC Gimbal Requirements. No Canting and Booster Canting Only .....	1-41
1-27.	Combination of Core and Booster Canting .....	1-42
1-28.	Comparison of Two Booster Propulsion System Designs .....	1-43
1-29.	Schematic Comparison of Two Booster Propulsion System Designs .....	1-44
1-30.	Integrated Propulsion Module-Engine Element .....	1-53
1-31.	Typical Family of ALS Launch Vehicles .....	1-54
2-1.	Baseline ALS Type Vehicle .....	2-2
2-2.	Geysering in a Cryogenic Feed System .....	2-3
2-3.	LOX Tank Aft .....	2-5
2-4.	Parallel Long Tanks—Five LH2 Tanks .....	2-7
2-5.	Parallel Long Tanks—Four LH2 Tanks .....	2-8
2-6.	Parallel Long Tanks—Extended LOX Tank .....	2-9
2-7.	Parallel Long Tanks—Five LH2 Tanks, Two LOX Tanks .....	2-10
2-8.	Concentric Tanks—LOX Tank Outboard .....	2-12
2-9.	Concentric Tanks—LOX Tank Inboard .....	2-13
2-10.	Toroidal LOX Tank .....	2-15
2-11.	Relative Weights of Alternative Tank Configurations .....	2-16
2-12.	Parameters for Typical ALS Trajectory .....	2-19
2-13.	Center of Gravity and Pitching Moment Changes .....	2-20
2-14.	Engine Gimbal Requirements and Thrust Loss from Canting .....	2-22
3-1.	SSME Plume Study .....	3-2
3-2.	Rocket Engine Air-Augmented Afterburning Concept .....	3-3

## **1.0 FULLY INTEGRATED, BOOSTER PROPULSION MODULE (BPM) CONCEPT**

The OEPSS study has identified some serious major problems that have plagued our launch operations requirements and compromised our launch capability. These problems are described in OEPSS Data Book Volume II - Ground Operations Problems. Some of the more prevalent operations problems related to current propulsion systems are briefly described below. This section will describe how these same problems can be avoided by considering the concept of a simple total integral system rather than be constrained by the complex use of discreetly separate systems.

### **1.1 GROUND OPERATIONS PROBLEMS**

Some examples will be given to illustrate how operational requirements can be driven by (1) systems that are not readily serviceable; (2) serial operations that are disruptive; (3) too much processing time is needed; (4) too many people are required; (5) complex support facilities are needed; and (6) hazardous operations are involved.

#### **1.1.1 Closed Aft Compartments**

An enclosed engine compartment at the boat-tail of the launch vehicle causes numerous ground operations problems because leakage of hazardous fluids can be confined, access is restricted, and complex ground support equipment (GSE) is required. Confinement of potential propellant leaks is a Criticality-1 failure. A closed compartment will require an inert gas purge system, a sophisticated hazardous gas detection system, and a personnel environmental control system. These systems in turn will require vehicle-ground interfaces and ground support equipment, all of which in turn will require separate specialized personnel to provide maintenance, checkout, and servicing. Moreover, inert gas purge poses personnel safety issues.

#### **1.1.2 Hydraulic System**

A hydraulic system represents another fluid distribution system that must be processed and maintained for flight operations. This involves distribution system leak checks, long periods of circulation for deaeration/filtering operations associated with fluid sampling and analysis, and functional check of all control systems. In order to process the flight system, all the basic hydraulic distribution system elements in the flight system must be duplicated in a ground support system to simulate pressure for the flight system checkout. The same operations and maintenance requirements are also required for the ground system.

The auxiliary power units to drive the hydraulic pumps represent an additional support system of prime mover, pumps, gearboxes, lube oil system, cooling system, instrumentation, distribution system, etc., which will require additional maintenance and checkout; and if a hypergolic-fueled auxiliary power unit is used, this will drive the need for a whole separate operations support infrastructure that dictates serial operations and the need for specially certified personnel to work in self-contained atmospheric protective ensemble (SCAPE) for fueling operations.

### **1.1.3 Lack of Hardware Integration and Many Artificial Interfaces**

A launch system that contains numerous separate, stand-alone systems proportionally drives up the number of duplicate components and interfaces. This in turn exponentially drives up the complexity and the operational support requirements. Each stand-alone system promotes artificial interfaces and each interface represents another “break point” in the system that must be checked and verified should the connection be broken. Each fluid interface represents a potential leak point requiring special attention for disassembly, reassembly, and leak checks. Separating fluid connections leads to potential sealing surface damage, which in turn requires repair of the sealing surface and, if severe, requires a line changeout. It is not uncommon in a critical system containing helium, hydrogen or oxygen to replace seals more than once to ensure an acceptable leak-free joint. An example of separate stand-alone systems is a launch vehicle propulsion system using multiple autonomous engines. The propulsion system will have as many duplicate propellant lines, valves, thrust chambers, turbopumps, control/avionics, heat exchangers, pneumatic control assembly, etc., and interfaces as there are engines.

## **1.2 OPERATIONALLY EFFICIENT PROPULSION SYSTEM**

To achieve operational efficiency for a flight system the design must be simplified to reduce operations required to support the system. An example will be used here to illustrate how the “lessons learned” from current operations experience described above are used to drive the design of a propulsion system concept for a heavy lift launch vehicle, such as the Advanced Launch System (ALS). The example will describe how the design can be simplified by “integrating” the multiple engines to eliminate as many components and interfaces as possible while maintaining the required thrust and control of the vehicle.

The baseline LOX/LH<sub>2</sub> ALS vehicle shown in Figure 1-1 will be used as a reference vehicle for comparing a traditional approach to designing a conventional propulsion system vis-a-vis with an integrated approach to designing an operationally efficient propulsion system. The ALS vehicle shown consists of a core vehicle and a side-mounted booster with a gross lift-off weight (GLOW) of 3,500,000 lb and a payload capability of 120,000 lb to low earth orbit (LEO). Both the booster and core vehicles are 30 ft in diameter and use 580,000 lb thrust (vac) LOX/LH<sub>2</sub> STME engines (Figure 1-2). The booster and core utilize seven engines and three engines, respectively, for their propulsion systems, and these are depicted as typical concepts in Figures 1-3 and 1-4.

### **1.2.1 Conventional Propulsion Module**

A typical conventional booster propulsion system for the ALS vehicle shown in Figure 1-3 is a propulsion module containing seven separate autonomous or stand-alone engines. These engines reflect traditional development as separate autonomous entities that will require all the subsystems necessary for each to function as an independent unit. Therefore, the propulsion module shown in Figure 1-3 will contain complete duplicate components and subsystems. The major ones are as follows.



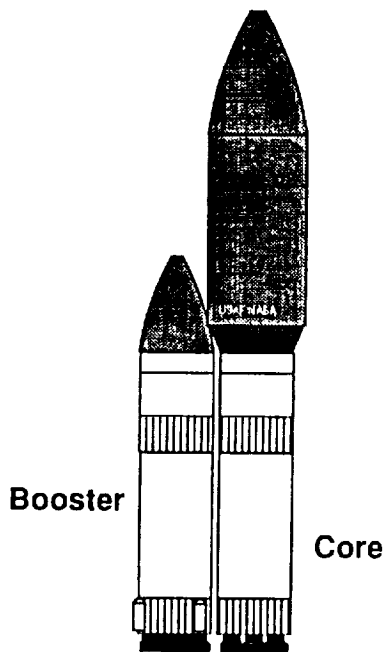

- Payload 120,000 lbs (LEO)
- GLOW 3,500,000 lbs
- Thrust/weight 1.30
- Booster vehicle 150' x 30' dia.
- Core vehicle 280' x 30' dia.
- Booster engines 7
- Core engines 3
- Engine thrust (vac) 580,000 lbs (STME)

**Figure 1-1. Baseline LOX/LH<sub>2</sub> ALS Vehicle**

- Thrust chambers 7
- Turbopumps 14
- Flexible propellant lines 14
- Main valves and actuators 14
- Gimbal actuators 14
- GOX heat exchangers 7
- Pneumatic control systems (PCA) 7
- Helium supply system 7
- Controls/avionics 7

The above propulsion system, with its numerous subsystems, components and interfaces, and difficult access for maintenance and service, reflects the complex systems that have generated our current problems. The operational complexity reflected in Figure 1-3 would be nearly three times the complexity we have on our present reusable launch vehicle. The operations problems will be further compounded if the propulsion module has a closed compartment and heat shield. In order to achieve the ultimate goal of the ALS vehicle to reduce the present cost for delivering payload to orbit by an order of magnitude, the operational cost for the ALS propulsion systems also must be reduced by the same corresponding equivalent.

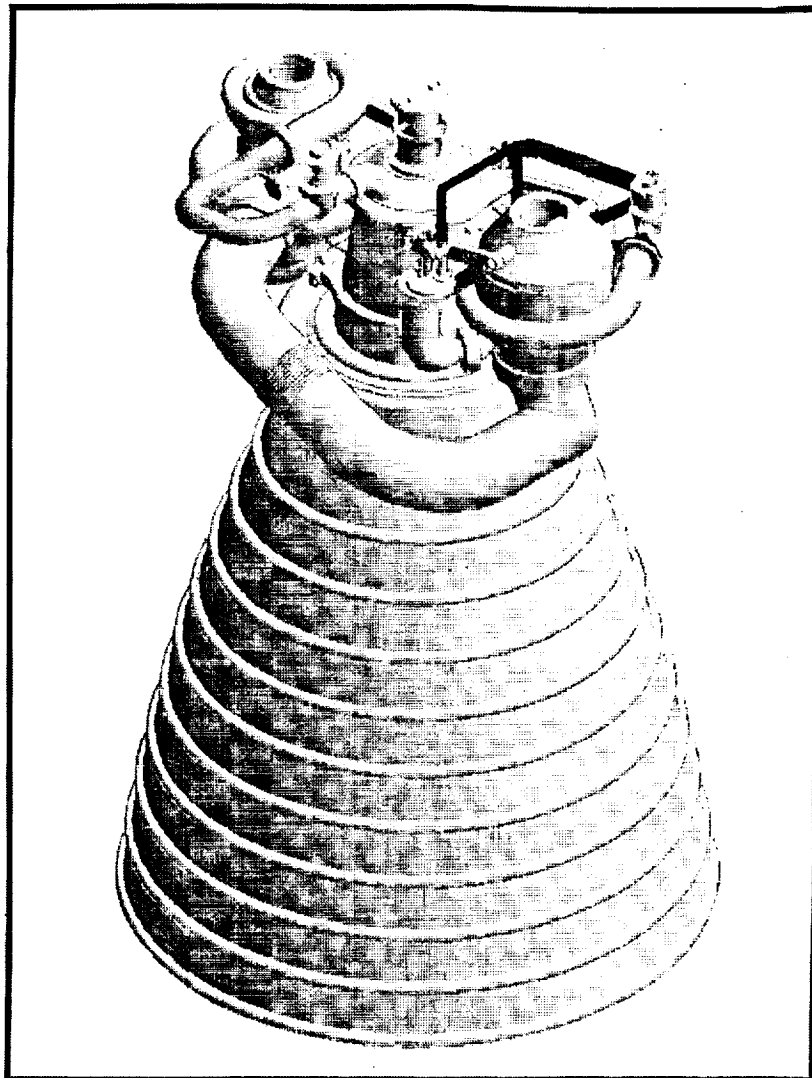

• Cycle	Gas Generator
• Thrust, lb (vac)	580,000
• Specific Impulse (vac)	431
• Chamber Pressure, psia	2,250
• Engine Mixture Ratio, MR	6.0
• Area Ratio, $\epsilon$	40
• Length, in.	144
• Exit Diameter, in.	83
• Gimbal Capability, deg	$\pm 10$

**Figure 1-2. Space Transportation Main Engine (STME)**

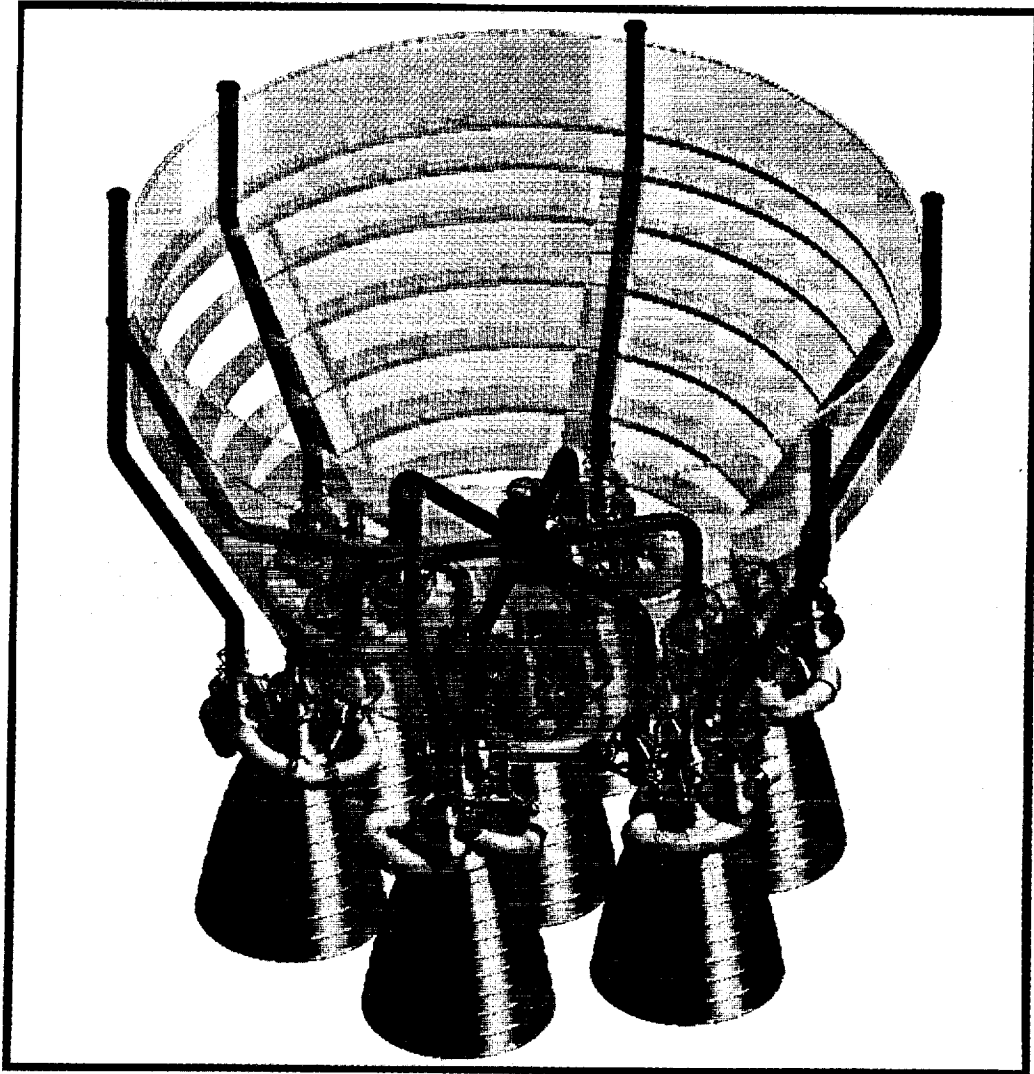

**Figure 1-3. Conventional Booster Propulsion System**

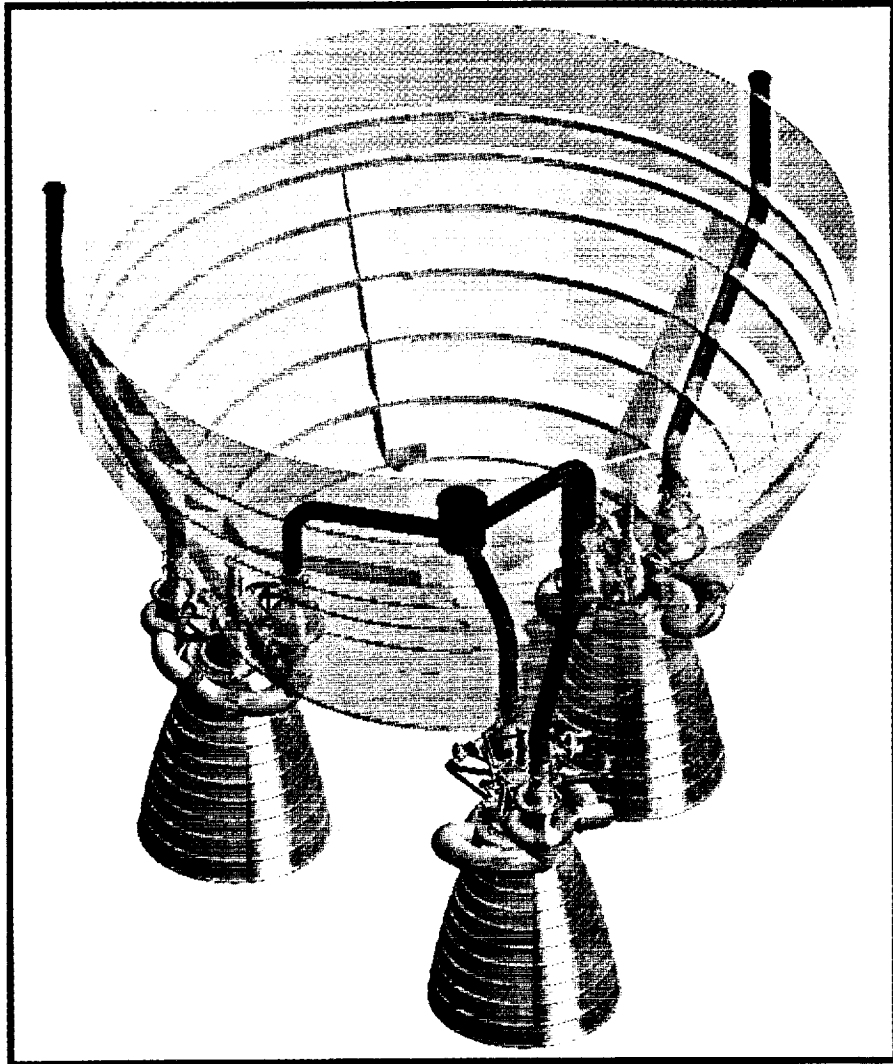

**Figure 1-4. Conventional Core Propulsion System**

## 1.2.2 Operationally Efficient Propulsion Module

To achieve a major reduction in the high operations cost associated with conventional propulsion systems, it is clear that the design of future propulsion systems must be greatly simplified so that operations problems identified in the OEPSS study and described above are eliminated. One approach to accomplish this, starting with a conventional design, is to "integrate" or eliminate as many engine components, subsystems, and interfaces as possible and still maintain reliable function and control of the total propulsion system. This unique approach, similar to that reported in Ref. 1, is briefly described below.

### 1.2.2.1 Simplified Design

As a departure from traditional design of a propulsion system, which simply groups together a number of separate engines, one way to simplify the design is to determine the fewest number of system components needed for the propulsion system to perform as a single engine. An example of a simplified, fully integrated propulsion system that will meet the baseline ALS vehicle mission is illustrated in Figures 1-5 and 1-6 for the booster and core vehicles, respectively. In this illustrative concept, a static nongimbaling booster is used and the core provides the thrust vector control for the total vehicle. To provide robustness and upthrust capabilities in the booster and core, an additional thrust chamber was added and the turbopumps were designed for twice the rated thrust and operation at lower speeds (similar to respective propellant pumps in the F-1 and J-2 engines on the Saturn V vehicle). The following overall simplification in major components and subsystems is achieved.

- Thrust chambers 8
- Turbopumps 4
- Fixed propellant lines 8
- Main valves and actuators 8
- Gimbal actuators (no hydraulic system) 0
- GOX heat exchanger 1
- Pneumatic control system 1
- Avionics/control 1
- Helium supply system 1

The operationally efficient propulsion module, therefore, is a parallel network system consisting of a propellant ring manifold that allows the turbopumps to feed all thrust chambers and to operate independently from any given thrust chambers. The addition of one thrust chamber achieved

---

<sup>1</sup>"A New Look at Chemical Rocket Propulsion System Configurations for Space-Stage Transport Systems," W.J.D. Escher, Propulsion, Power and Energy Division, NASA Headquarters, March 1990

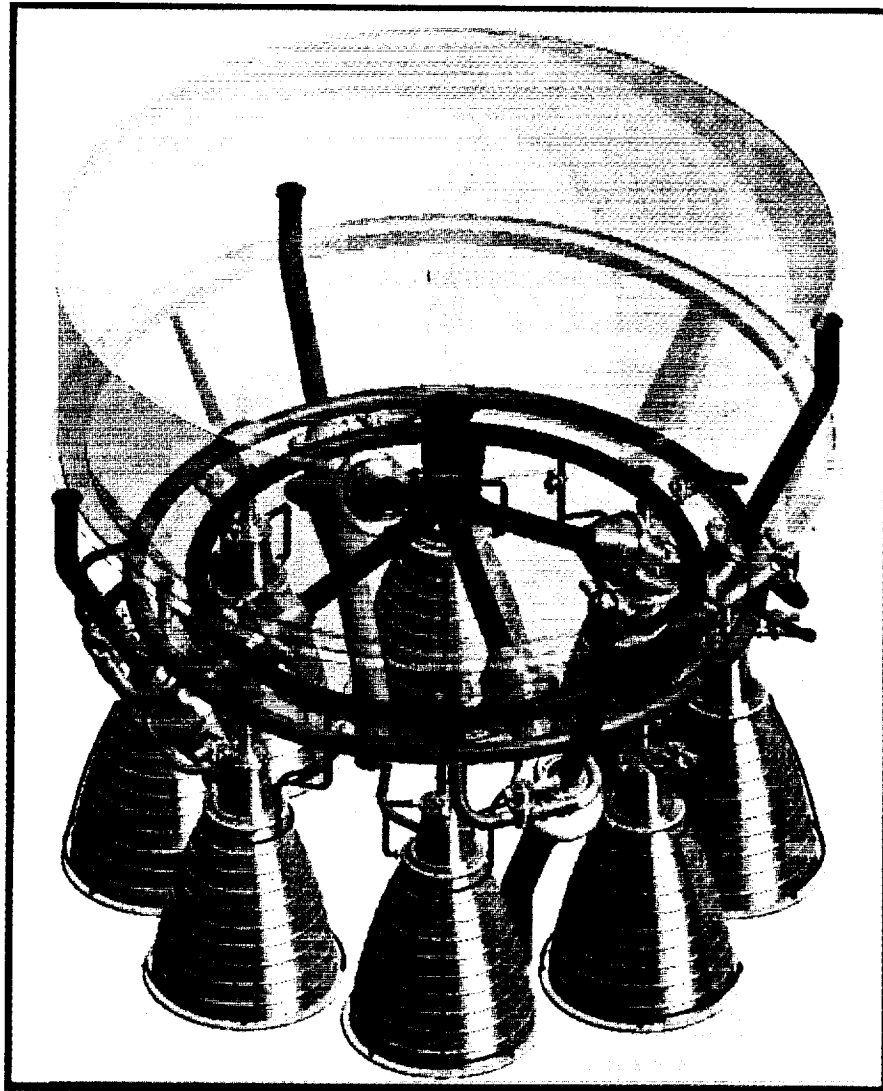

**Figure 1-5. Integrated Booster Propulsion Module - Engine**

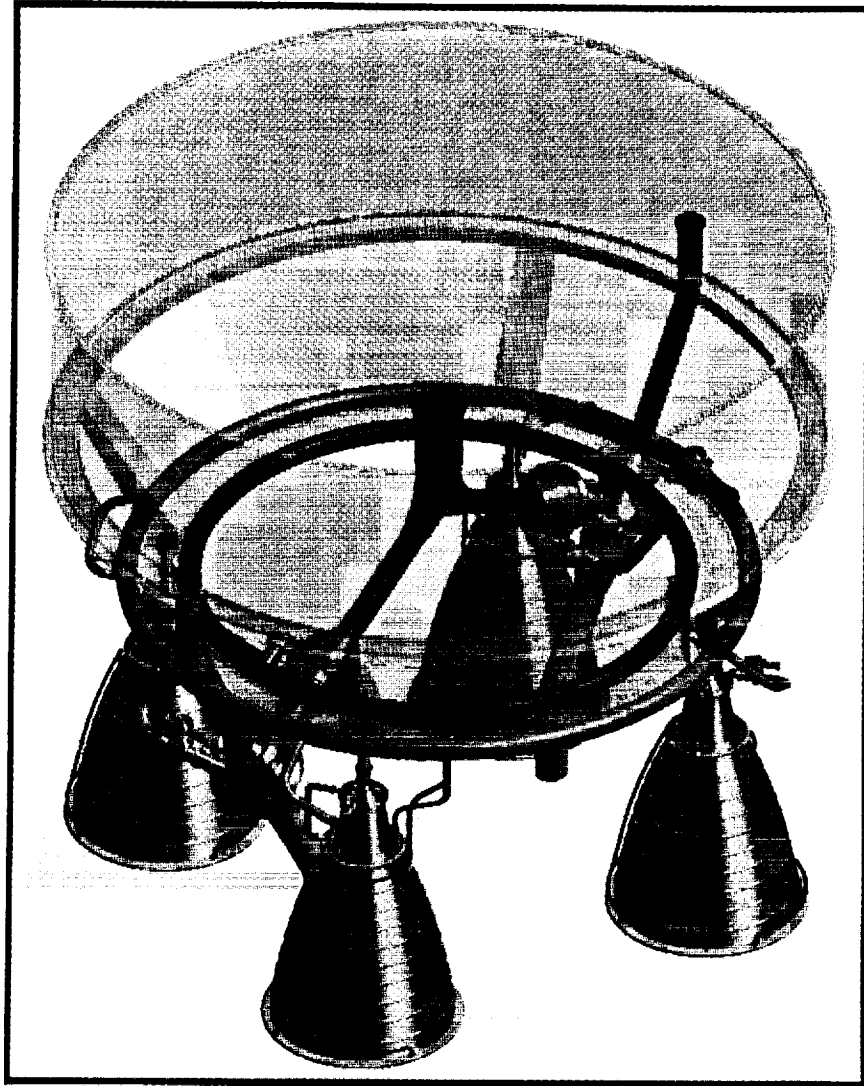

**Figure 1-6. Integrated Core Propulsion Module - Engine**

complete symmetry and commonality between the booster and core propellant feed system and thrust structure. The propulsion system having an open compartment to facilitate access and ensure safety will have components selectively located and thermally isolated. The basic engine–element for the integrated booster propulsion system is shown in Figure 1–7 and the core propulsion system (Figure 1–6) is simply made up of two of these engine–elements. It is particularly noteworthy that the operationally efficient propulsion module addresses seven of the top 10 major operations problems identified by the OEPSS study.

#### **1.2.2.2 Single Helium System**

The requirements for gaseous helium (GHe) in a LOX/LH<sub>2</sub> engine system is driven by the need for LOX pump intermediate seal purge and engine prestart purge which are baselined for the ALS. Since the on–board GHe is already available, it is also a source for pneumatic control of the engine valves, for turbine spin start, and for engine shutdown purge. The issue, therefore, is not usage but how to simplify the operations and maintainability of the complex helium system. The large number of components in the separate helium supply system is shown in Figure 1–8 and this can be significantly reduced to increase operability by integrating the system as shown in Figure 1–9. Current study showed that by integrating and relocating the GHe supply to a common central engine location, not only realizes a weight savings ( $\approx 500$  lb), but the system becomes easier to check out and maintain due to greater accessibility and large reduction in the number of components.

#### **1.2.2.3 Single Avionics/Control System**

The avionics system provides needed functions for a propulsion system such as engine control, thrust vector control, and fault detection. Conventional stand–alone engines utilize separate controllers for each engine which must be integrated with the flight controller software, usually accomplished by special interface black boxes. This results in increased operations for checkout, software changes, and engine/vehicle interface verifications.

The integrated propulsion module engine utilizes a single dual redundant controller shown in Figure 1–10 that integrates the propulsion instrumentation, with built–in test capability, to provide a more operationally efficient and maintainable design. This eliminates the tedious and time–consuming manual checkout and fault isolation required of current systems. The single controller utilizes a two–channel, multiplexing bus to provide all the data processing requirements for the entire module. Control commands to the valves and the data from the component sensors are transmitted to and from the controller via standard interface units. These units are designed to minimize operations at the launch site by the use of a distributed architecture. This means less wiring, less wiring checkout, and lower weight. This architecture makes use of today’s advanced technology in computer hardware and software to permit all engine functions to be integrated into a single propulsion system controller.



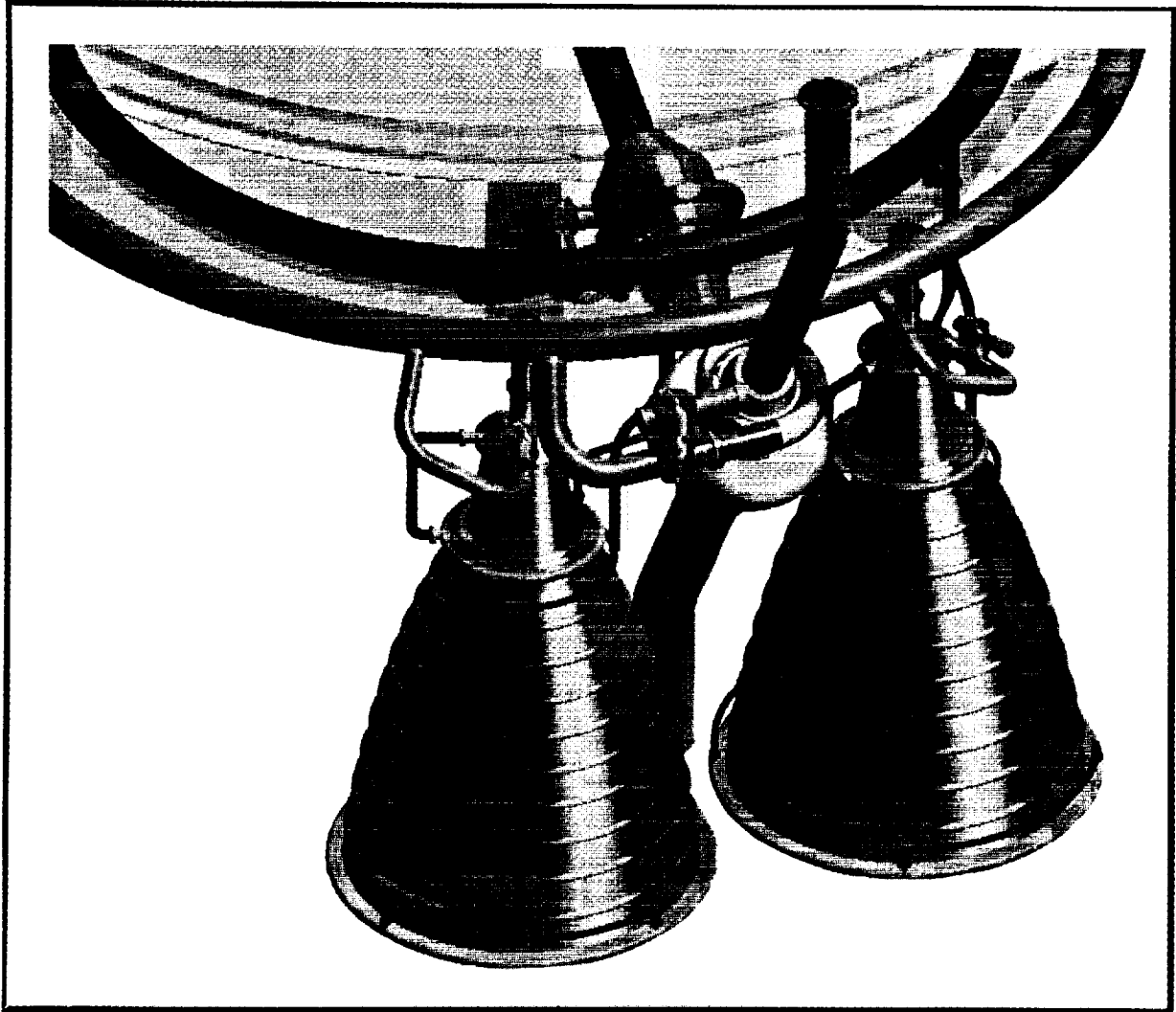

**Figure 1-7. Integrated Propulsion Module - Engine Element**

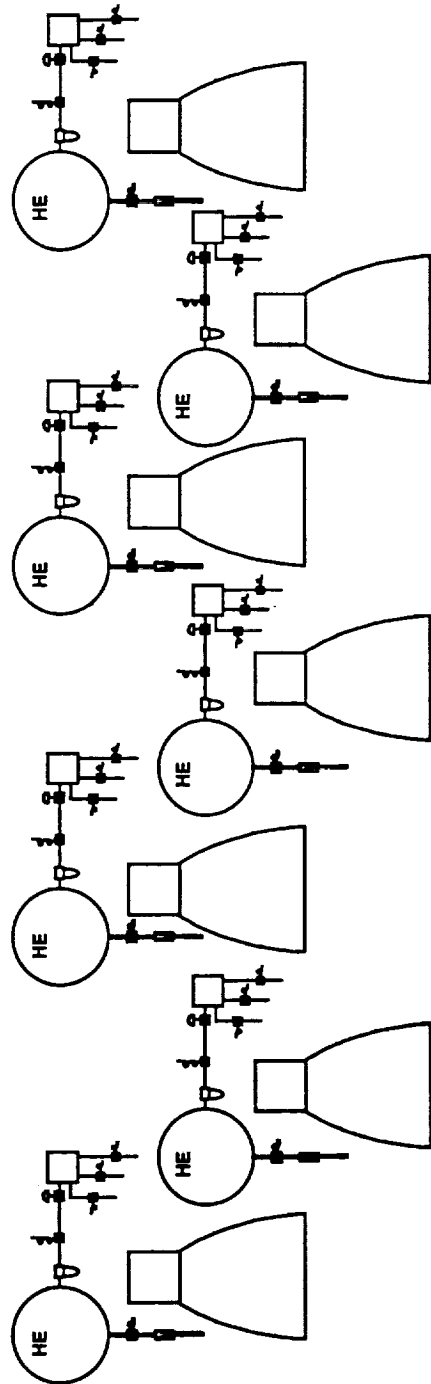

7- Helium tanks  
 63 - Valves, regulators, filters and PCA's  
 Many leakage and maintenance requirements

Figure 1-8. Separate Engine Helium Supply Systems

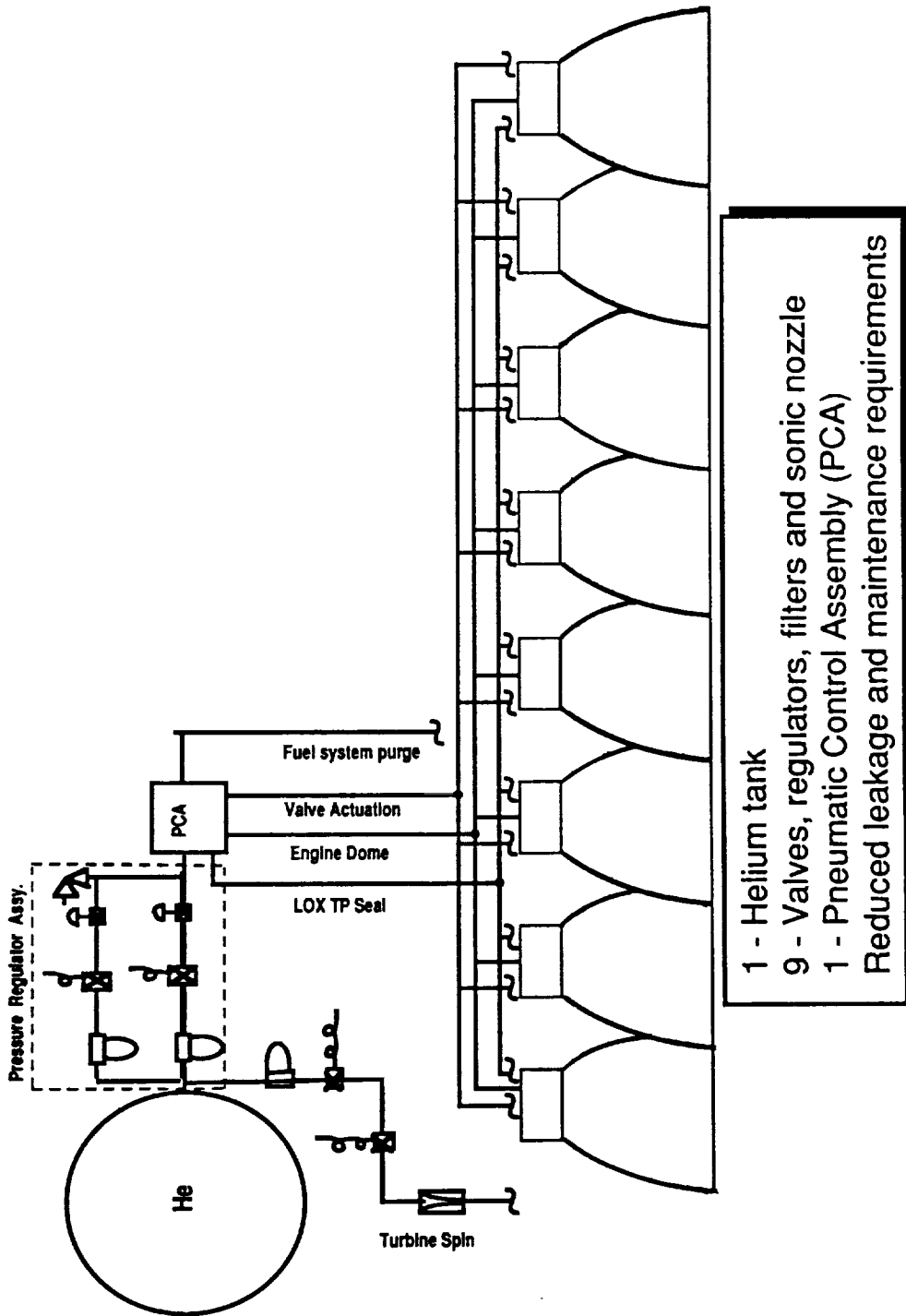
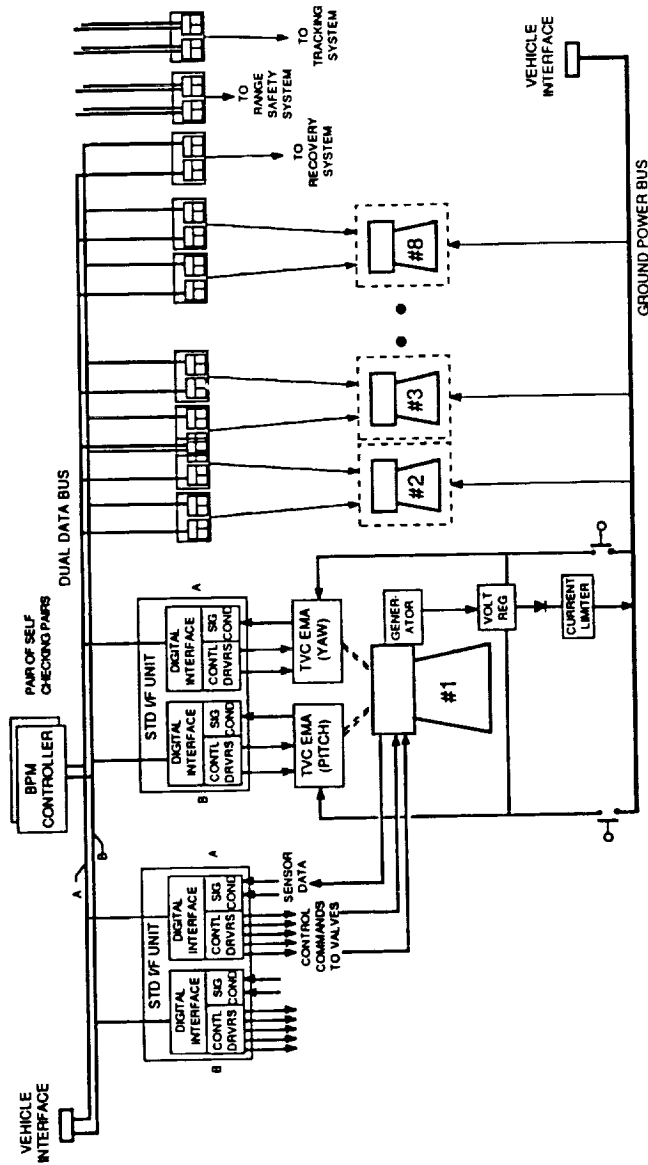

Figure 1-9. Integrated Engine Helium Supply System



A - CHANNEL  
B - CHANNEL

Booster Propulsion Module - Avionics Architecture  
Shown with Optional TVC EMA Control

**Figure 1-10. Booster Avionics/Control Schematic**

#### **1.2.2.4 Single LOX Pressurization System**

The GOX heat exchangers and flow control valves in the LOX tank pressurization system pose potential safety hazards and are primary operations concerns. For the integrated propulsion module, a single GOX heat exchanger (in the LOX pump-turbine exhaust) and hot gas orifice are used. For redundancy a second heat exchanger could be added and still simplify the subsystem by 50% compared to using conventional stand-alone engine systems.

#### **1.2.2.5 Thrust Vector Control**

The thrust vector control (TVC) system for a launch vehicle has been a major operations problem for multiple engine systems, especially if the design includes hydraulic actuators and requires TVC for each engine. The engine gimbaling requirement complicates the vehicle design by requiring gimbal actuators, complex flexible inlet feed duct assemblies, sophisticated heat shields, and hydraulic or electrical power to drive the gimbal actuators. To reduce the number of TVC actuators required and to simplify the operational requirements for the ALS vehicle, a static-booster is used (eliminating gimbal actuators, controls, power, and flexible propellant lines) and only the core will gimbal. Analysis shows that the ALS trajectory can be met by a static booster with engine cant angle of 10 deg and a gimbaling core with engine cant angle of 5 deg. The core gimbal angle for a worst case scenario of high wind shear and engine-out is approximately 9 deg and the maximum gimbal angle is approximately 12 deg occurring at booster shutdown and separation. These TVC gimbal angle requirements are very close to those required for the conventional engines. A more detailed discussion of TVC is given in a later section.

### **1.3 FULLY INTEGRATED BPM CONCEPTUAL DESIGN**

A top level conceptual design study was made on the integrated booster propulsion module to explore its viability as an operationally efficient system for future new launch vehicles. Although system integration could take many forms, the OEPSS concept eliminated components and subsystem to a maximum while staying within the design state-of-art utilized by the ALS vehicle and the STME engine. The design goal is to: (1) provide significant reductions in operations facility, equipment, personnel, and costs; (2) eliminate propulsion and avionics components and systems that drive operational complexity (i.e., bleed systems, pogo systems, etc.); and (3) provide cost-effective designs using commonality where possible. A summary of design goals and approaches is presented in Table 1-1.

#### **1.3.1 Design Configuration**

In the integrated booster propulsion module shown in Figure 1-5, the total propulsion system is treated as a single engine using only a minimum of components and auxiliary subsystems to produce thrust. The specific design objectives of the BPM are presented in Table 1-2. The eight STME-derived thrust chambers (regeneratively cooled) are fed from high pressure ring manifolds which are pressurized by four STME-derived turbopump sets. A single direct baffled line from the LH<sub>2</sub> tank feeds the LH<sub>2</sub> pumps, and the LOX pumps are fed individually from lines connected to the forward

**Table 1-1. Integrated Propulsion System Design Goals**

<b>Design Goals</b>	<b>Design Approach</b>	<b>Benefits</b>
1.4 turbopump sets feeding 8 booster TC's and 2 feeding 4 core TC's	1. Increase pump size and design-in 33% performance margin for pump out, & thrust chamber out conditions.	1. Reduces number of pumps. Uses SOTA TC, and pump technology.
2. Single helium system for all TC's	2. Combine all helium requirements into single helium system module LRU	2. Lowers cost, no. of components, operations.
3. Eliminate prevalues	3. Delete requirement for isolating propellant after fill. Eliminate functional reason: recirc. Assess safety implications.	3. Lowers cost, no. of components, operations.
4. Eliminate bleed system	4. Provide clear path for gas bubble migration from the MOV, MFV interface. Design system with no high points.	4. Lowers cost, no. of components, operations.
5. Maximize Accessibility	5. Design for easy access from base or side access to avoid problems like STS	5. Minimizes operation tasks in case of changeout or installation
6. Eliminate pogo suppression	6. Mount thrust chambers to stiff outer structure thus driving low frequency dynamic interactions to higher frequencies.	6. May eliminate pogo suppression hardware
7. Eliminate active recirc system	7. Design for natural recirc	7. Lowers cost, no. of components, operations.
8. Use Foam Insulated Lines	8. Use pour in place technique and reinforce sensitive areas with Kevlar-resin wrap	8. Lowers operations cost, lighter
9. Single Helium spin start	9. Provide spin start for one turbopump set and bleed off hi press manifold for start-up of other three	9. Simplifies start-up & minimizes He req't's.
10. Maximize Common Elements	10. Design feedlines, components, and structure to be identical between core and booster.	10. Greatly lowers mfg costs, spares inventory, & chg out simplicity
11. Eliminate Pneumatic Valve controls	11. Replaced pneumatics with EMA's.	11. Reduces failure paths, no. of components, checkout operations.
12. Simplified pressurization system	12. Accomplish by integrating all pressurization lines into single pressurization loop. Eliminate LOX flow control valve and use orifice and helium prepress.	12. Lowers cost, reduces safety concerns, no. of components, & operations.
13. Simplify Heat Shield	13. By locating engine hardware forward of thrust chamber and feedline VF	13. Simplifies heatshield design and lowers costs.

**Table 1-2. Specific Design Goals for Booster Propulsion Module**

**Desired Design Goals/Approach**

Propulsion (General)

- Maximize accessibility and locate components for simple change-out capability
- Design with Robust Margins (10 - 15%)
- Design system to accept and tolerate higher levels of contamination or leakage
- Select materials to be compatible with salt water or salt spray.
- Provide automated diagnostic systems and built-in sensors to eliminate most ground checkout operations (i.e. leak check capability, functional, etc...)
- Eliminate Booster Ground Interfaces and minimize Propulsion Module to Booster Vehicle Interface
- Provide Quick Change-Out Capability

Propellant Feed System

- Maximize common elements
- Eliminate Prevalves
- Use Electro-mechanical Actuated Valves (EMA's), eliminate pneumatics & hydraulics
- Use Foam Insulation for Lines
- No Recirc Pumps on the Flight Vehicle
- No Ground or T-0 Umbilicals on booster element
- Eliminate Pogo Suppression; Engine Hard Mount
- Perform Fill & Drain Through Core Vehicle; No PM I/F
- Use Simple Separation Disconnects (No 17 inch STS Disc's)
- No Exposed Bellows for Flex Lines (Design for 75-100% unexposed flow area)
- All Welded Construction Where Possible

Turbo Machinery

- Eliminate intermediate seal purge req't
- Use 4 Units to feed 8 Thrust Chambers (LOX & LH2)
- Vertical Mounting to allow Natural Pre-conditioning
- No Boost Pumps; Higher NPSP or Pump Design to Accommodate
- Located for Easy Accessibility and Changeout
- Pre-launch Chill by Gravity Feed; No Prop Conditioning
- Operate at well below max operating (-33%) to increase life, and limit bearing wear

GG & Exhaust

- Possible Gimbaling of Exhaust for TVC

Thrust Chambers & Components

- Eliminate anti-slam requirements at start-up (complicates valve design)
- Eliminate Thrust Chamber Alignment Operation (Design to accept tolerances)

Booster to Module Disconnect Panels

- LO2 Feedline disconnect- minimize number of and complexity
- LH2 Feedline disconnect at Sump - minimize number of and complexity
- Electrical/Data Interface Disconnect - minimize number of and complexity

Pressurization & Helium System (Plumbing, Valves, Orifice)

- No Flow Control Valve on LO2 Side; Use orifice approach & ground helium prepress
- Consider "Tridyne" Pressurization Method
- All Welded Construction Where Possible
- Single He System
- Eliminate Intermediate seal Purge
- Propellant Line Purge

mounted LOX tank. All pumps, thrust chambers, and associated plumbing are controlled by a single electronic controller (dual redundant). The lines and components are placed to facilitate initial installation, reduce tooling and GSE, and to provide ease of access for changeout at the launch site. A simple system fluid schematic is shown in Figure 1-11.

To eliminate gimbaling, the booster thrust chambers are canted approximately 10 deg off centerline. All thrust vector control is supplied to the vehicle by the four core vehicle thrust chambers which are gimbaled by electromechanical actuators. In addition, all hydraulics have been eliminated from both the booster and the core. The feed system uses separate but common LOX and LH<sub>2</sub> high pressure manifolds and separate but common feedlines between the booster and core vehicles. Also, the helium systems have been simplified into one central system supplying helium to all propulsion components and the pneumatics have been completely replaced by electromechanical actuated valves.

Structurally, the BPM concept is simple and is based on proven vehicle designs (S-2, SIVB) and incorporates new manufacturing technology for low cost. The primary thrust structure uses a lower T-stiffened ring for thrust chamber mounting and uses a lightweight inverted conic structure fabricated from sheet metal, externally stiffed with T-hat sections, and an upper ring to react radial thrust loads and to distribute the loads in shear in the cone web and booster outer skirt. The circumferential mounting of the thrust chambers onto a solid and rigid mounting base will minimize or eliminate dynamic interaction and potentially eliminate the POGO problem.

#### **1.3.1.1 Commonality**

One of the design approaches for the BPM is to provide maximum hardware commonality between the booster and the core. This is reflected in the feedline design where the LOX and LH<sub>2</sub> lines are identical for both the core and booster. The structural concepts are also similar in that they both use a simplified, low cost aluminum conic structure. The avionics equipment will be identical between the core and the booster with the exception that the booster contains the software/hardware for the separation (or recovery portions of the mission), and the core contains additional software for the second stage. Other propulsion system hardware such as the pressurization lines and valves will also have identical designs and layouts.

#### **1.3.1.2 Turbopump Placement**

For the BPM concept, the LOX pumps are located on the outside of the LOX high pressure ring manifold and the LH<sub>2</sub> pumps are mounted on the inside of the LH<sub>2</sub> high pressure ring manifold, and are canted at 45 deg. The turbopumps are closely coupled and the traditional wraparound turbine exhaust duct is eliminated. The pumps are remotely located forward for c.g. reasons and mounted close to the centerline for easy removal through the base of the module. This is done to allow gravity to assist in the removal of the pumps, and the layout is such that the removal can be accomplished through the base opening.



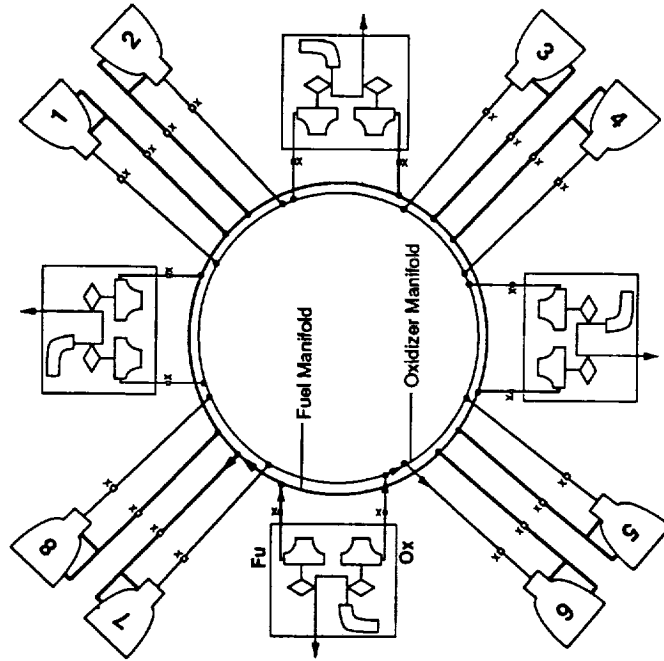
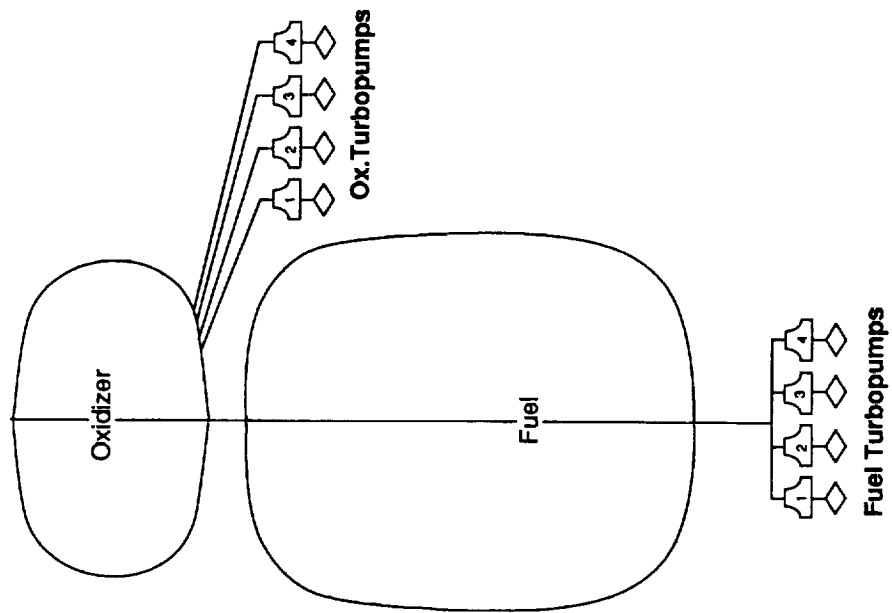

**Figure 1-11. Integrated Booster Propulsion Module Fluid Schematic**

### **1.3.1.3 Feedline Design**

The propellant feedlines are designed to achieve commonality within the booster module and also with the core module. This means that LH<sub>2</sub> and LOX feedlines are all identical for the booster as well as the core. This was done to greatly lower manufacturing and operations costs. The design also included a combined line and flex joint design that takes up the entire thrust chamber range of motion thus eliminating the need for traditional engine mounted scissor ducts or equivalent. The high pressure ring manifold is common between the LH<sub>2</sub> and LOX systems and is approximately 25 ft in diameter. The manifold line diameter is 12 in., with the pump outlet (or manifold inlet) lines sized at 7 in. diameter. The eight thrust chambers are fed by eight 5-in. diameter LOX lines and eight 5-in. diameter LH<sub>2</sub> lines. For preliminary estimates on dimensions, the feedlines were sized for maximum velocity based on existing propulsion feed system designs.

For line insulation, instead of using vacuum jacket, which is a high maintenance intensive design, a pour-in-place polyurethane is used and, to stiffen areas exposed to high damage potential, a Kevlar or graphite-resin wrap is used.

### **1.3.1.4 Thrust Chamber Placement**

The placement of the eight thrust chambers circumferentially mounted and equally spaced along the outer diameter of the ring manifold resulted primarily from the design goal to eliminate pogo suppression systems and to meet the goal of feedline commonality. Total commonality between the booster and core configurations is seen in Figure 1-12. Other considerations included booster/core flight control, feedline commonality, weight, cost, ease of installation and maintainability. By locating the thrust chambers along the outer diameter, low cycle oscillations are essentially eliminated. This is because of the strong and rigid structural connection of the thrust chambers to the booster primary structure which drives the dynamic interactions to higher frequencies. The elimination of any center engine(s) or thrust chamber(s) by using circumferential mounting reduces the pogo concern since the possibility of large structural deflections (center beam) is not possible. Also, the commonality between the booster and the core is greatly improved since special lines to center engine(s) are not required.

### **1.3.1.5 Gas Generator Exhaust**

The gas generator exhaust from the four LOX turbopumps are routed from each of the four turbine exhausts out the base of the BPM through its own nozzle as shown in Figure 1-4. This was done to simplify the thrust chamber design of the main thrusters and to reduce the base heating problems that may occur during first stage ascent.

## **1.4 FULLY INTEGRATED BPM FUNCTIONAL OPERATION**

The propulsion fluid schematic for the BPM is shown in Figure 1-13 (and for the core in Figure 1-14). The systems not shown in the BPM fluid schematics are the vent systems and the antigeyser systems because they are assumed to be the responsibility of the booster vehicle. The systems eliminated in the BPM are the pogo systems, recirculation system, and the pneumatic systems.

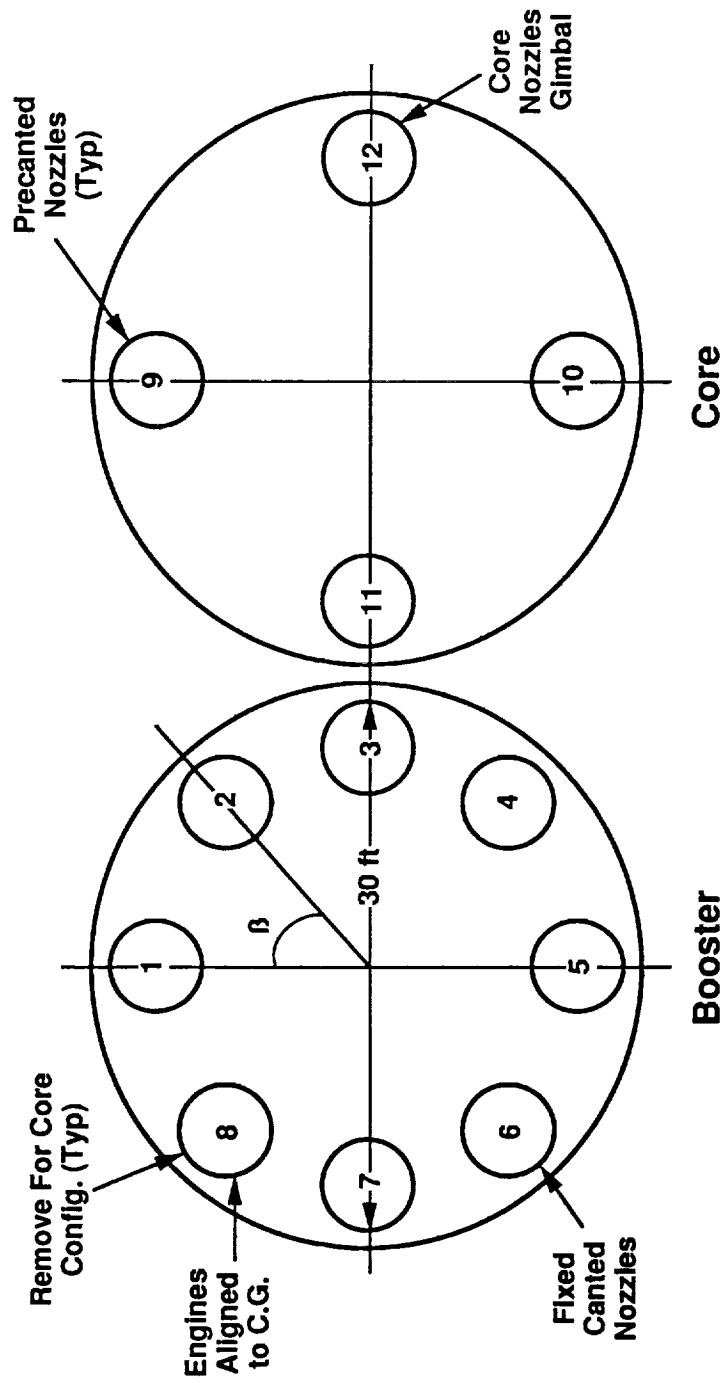

Figure 1-12. 8/4 Booster-Core Configuration Achieves Maximum Commonality

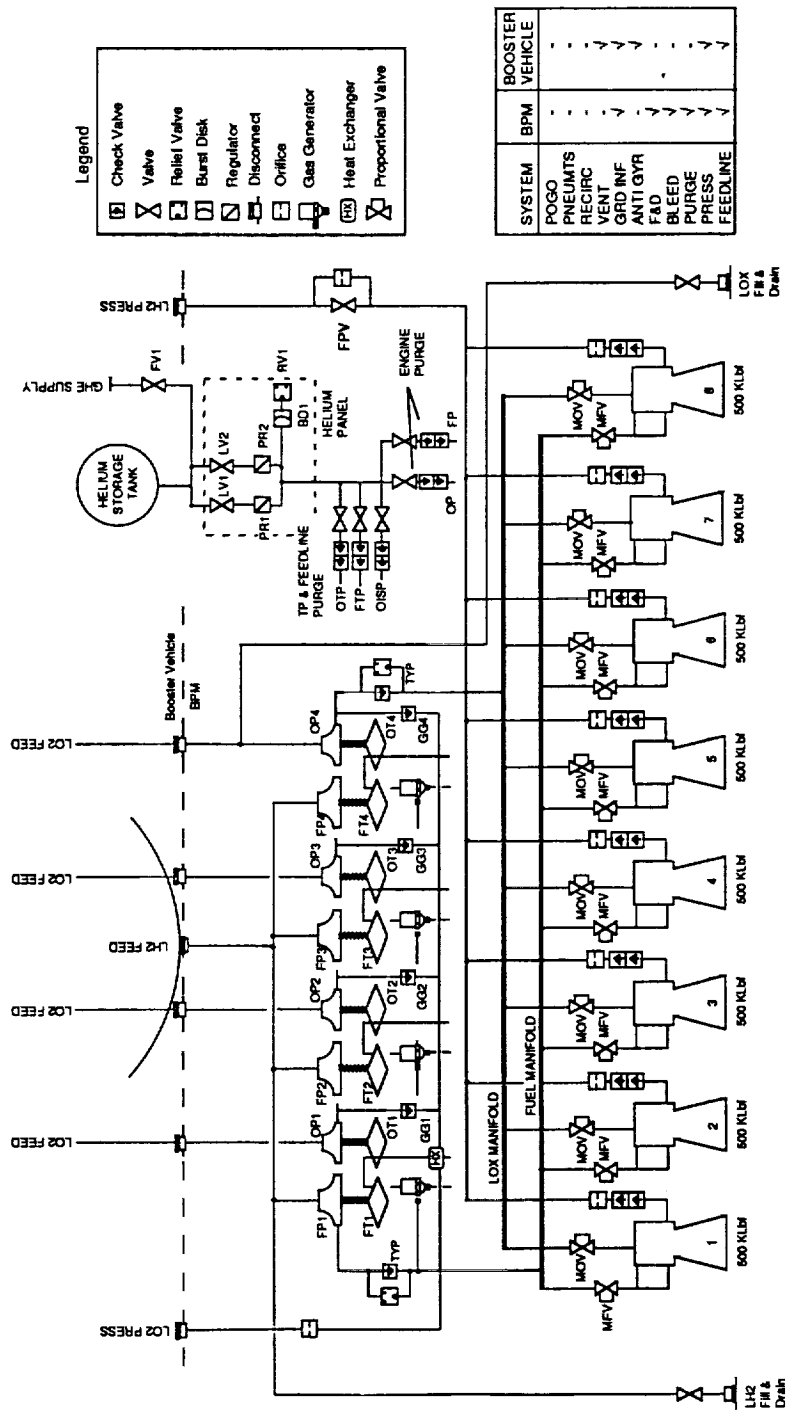

Figure 1-13. Integrated Booster Propulsion System Fluid Schematic

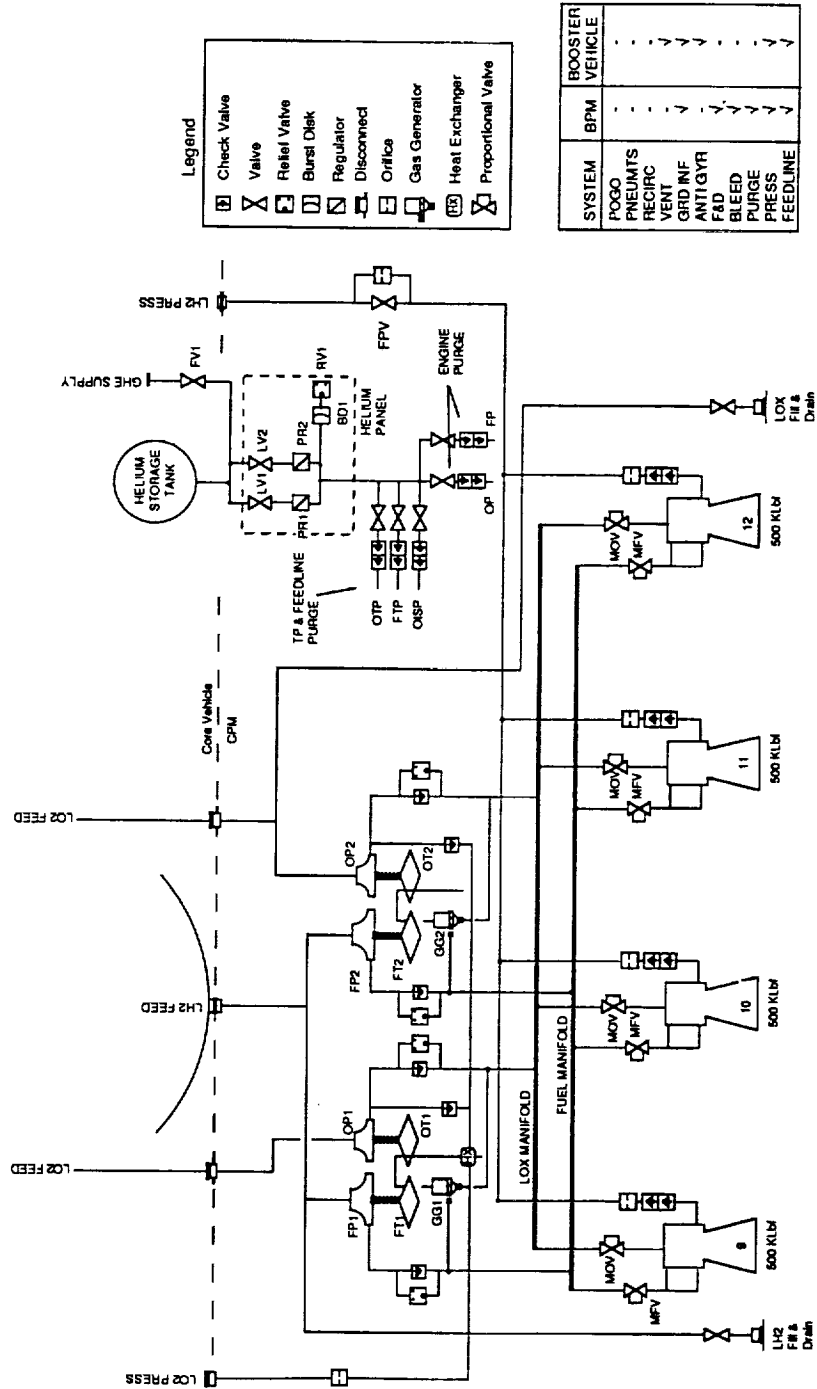

Figure 1-14. Integrated Core Propulsion System Fluid Schematic

As shown in the schematic flow diagram for the booster (Figure 1-13), a single feedline from the LH<sub>2</sub> tank is manifolded to the inlets of four hydrogen turbopump sets. The pumps increase the pressure head and deliver flow into a high pressure fuel ring manifold. This manifold distributes the flow to the eight thrust chambers via eight identical lines and is controlled by the main fuel control valve. This valve provides both shutoff and flow control functions required for pump-out capability. For the LOX side, four oxidizer feedlines from the LOX tank feed directly into each LOX pump, which delivers flow to the LOX ring manifold and thence to the eight thrust chambers. The main LOX control valves perform similar functions as the main fuel valves.

A major simplification shown in Figure 1-13 is the single helium supply and control panel. By removing and integrating the components from the engines and remotely mounting them within the module, we have eliminated a separate helium supply and control panel for each engine.

The fluid schematic represents a gas generator cycle with a regenerative cooled nozzle. Hot gas is tapped off the chamber to provide pressurization to the LH<sub>2</sub> tank, and high pressure liquid is tapped off the oxidizer pumps and heated by the GG exhaust for the LOX tank pressurization. One key feature is the absence of a flow control valve in the hot LOX system. Previous analysis has shown that the use of an orifice with a prelaunch helium prepressurization is possible.

#### 1.4.1 System Flow-Balance for Integrated BPM

The Rocketdyne on-design engine balance code was modified to determine the BPM operating conditions of flowrates, pressure, and temperatures throughout the engine system. The input data includes heat loads, cooling channel pressure drops, component pressure drops (valves, injectors, etc.), feedline and manifold pressure drops. The JANNAF simplified method was used for calculating thrust chamber performance. A simple system flow balance schematic for an engine-element of the integrated BPM is shown in Figure 1-15 and the method of analysis is illustrated in Figure 1-16. The integrated BPM is designed to operate at a throttled-down condition at a nominal thrust of 85% rated thrust (with all thrust chambers and turbopumps operating) to provide a 15% operating margin for up-thrust capability in the event of a thrust chamber-out condition. The integrated BPM engine balance at this nominal condition is shown in Figure 1-17.

The Rocketdyne off-design computer code was used to determine the operating conditions of the integrated BPM when a condition of both a thrust chamber-out and a turbopump (set)-out occurs. The results indicate that the chamber pressure ( $P_c$ ) varies nearly directly proportional to chamber thrust and that turbopump flowrates are very nearly inversely proportional to the number of turbopumps (sets) operating. With both thrust chamber-out and turbopump-out condition, i.e., with only seven thrust chambers and three turbopumps operating, the thrust chamber(s) will be operating at 100% rated thrust and the turbopump(s) will be operating at 100% rated speed. This operating condition is shown in Table 1-3. The nominal operating condition, where all eight thrust chambers and four turbopumps are operating, is also shown in the table. This equivalent engine-out condition is discussed in the next section.

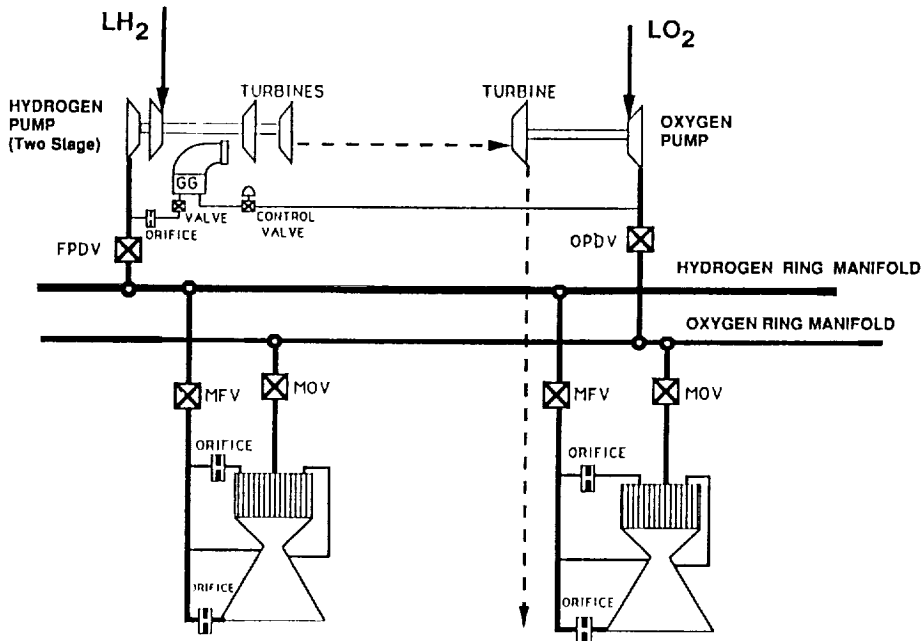

Figure 1-15. Booster Propulsion System Flow Balance Schematic

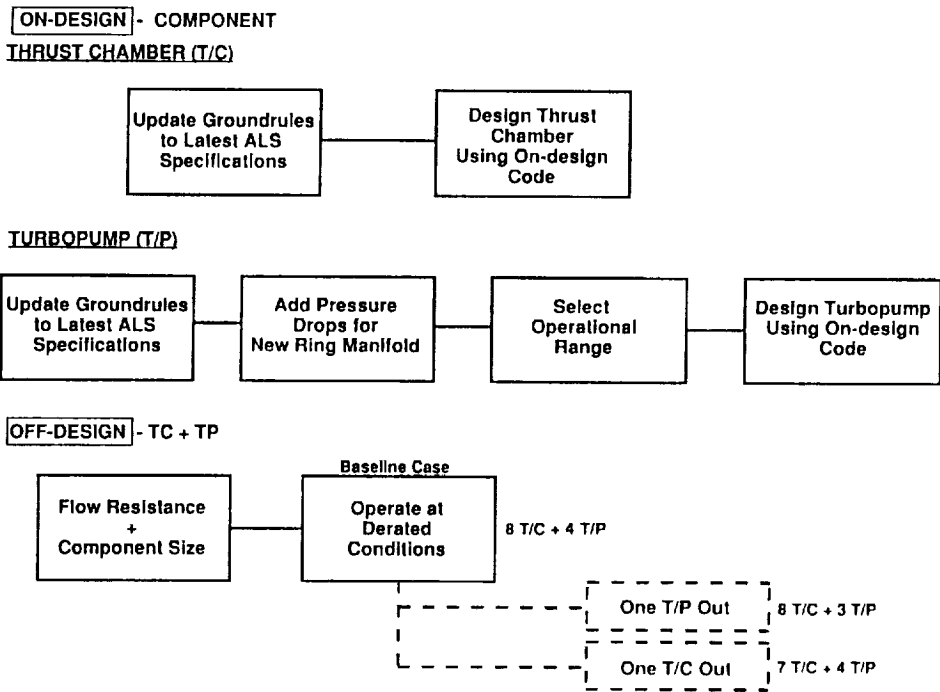

Figure 1-16. Integrated BPM Method of Analysis

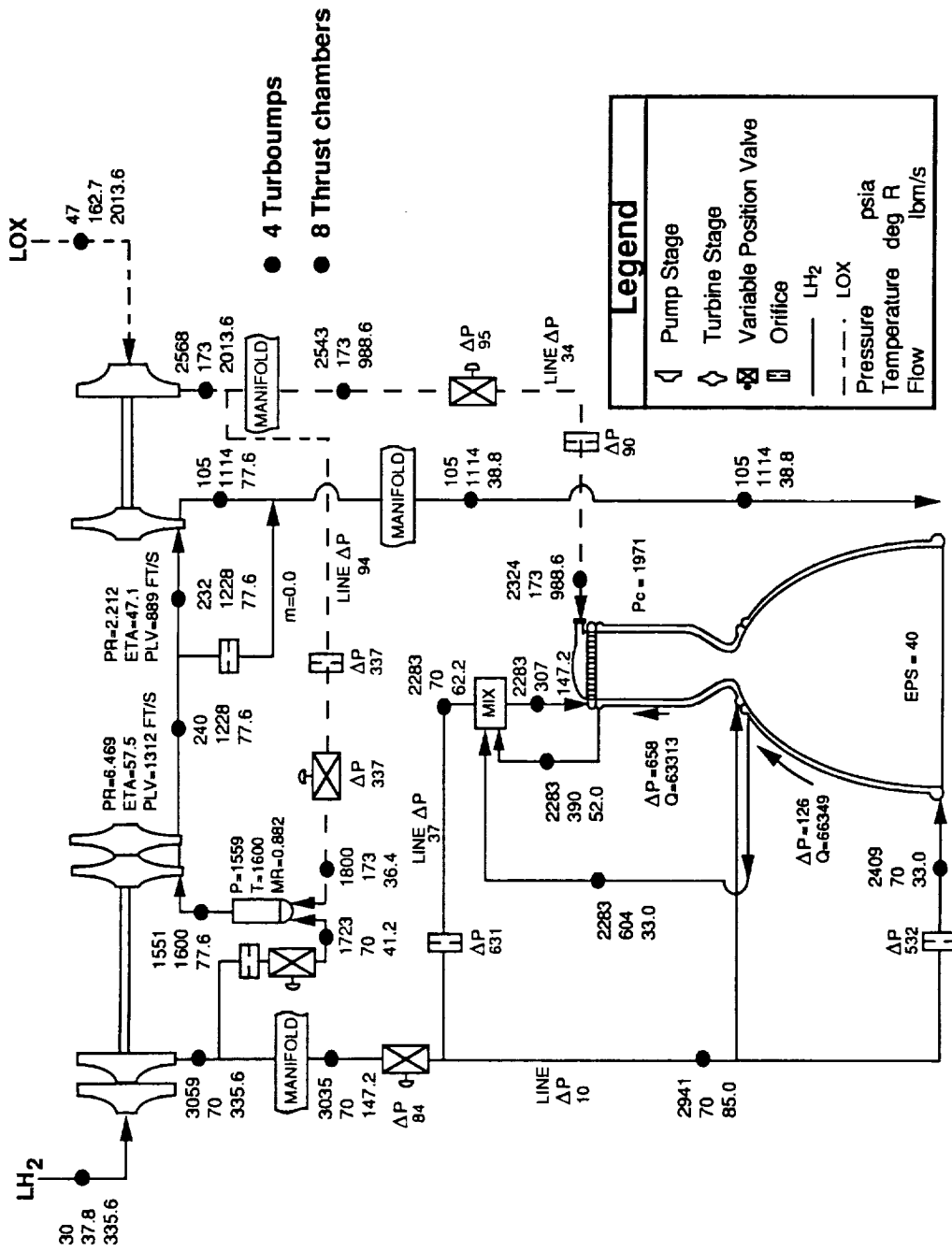

Figure 1-17. Integrated BPM Engine Balance



Table 1-3. Integrated BPM Design Data

PARAMETERS	ON-DESIGN	BASELINE
# of Thrust Chamber	7	8
# of Turbopump	3	4
<u>Thrust Chamber</u>		
F (lb)	567781	497000
P <sub>c</sub> (psia)	2250	1971.3
MR <sub>T/C</sub> (—)	6.773	6.701
(I <sub>sp</sub> ) <sub>T/C</sub> (sec)	438.4	438.5
(I <sub>sp</sub> ) <sub>gg</sub> (sec)	258.2	257.0
(I <sub>sp</sub> ) <sub>Eng</sub> (sec)	—	431.6
(I <sub>sp</sub> ) <sub>SL</sub> (sec)	—	365.4
$\dot{w}_f$ (lb/sec)	166.6	147.166
$\dot{w}_{ox}$ (lb/sec)	1128.4	986.16
<u>Pump</u>		
$\dot{w}$ (F/o) (lb/sec)	447.3/2683.7	335.581/2013.567
Pd (psia)	3568/3053	3058/2568
rpm (rpm)	16281/6209	14654/5521
HP (Hp)	118390/37215	78214/24002
$\eta$ (—)	0.7620/0.7967	0.7408/0.7772
<u>Turbine</u>		
$\dot{w}$ (lb/sec)	111.7/111.1	77.627/77.627
Pr (—)	6.5/2.221	6.469/2.212
$\eta$ (—)	0.5990/0.5149	0.5753/0.4707
<u>Gas Generator</u>		
F <sub>gg</sub> (lb)	28839	19952
$\dot{w}$ (lb/sec)	59.5/52.2	41.248/36.378
P (psia)	2250	1559
T (°R)	1600	1600

Turbopump operating maps were generated for the integrated BPM and are presented in Figures 1-18 and 1-19. The nominal operating point, with all systems operating and the rated design operating point with both thrust chamber-out and a turbopump-out condition, are shown in the figures.

### 1.4.2 Component-Out Capability

This is an area where the integrated system is uniquely different from the conventional system. As seen in Figure 1-5, the integrated propulsion module performs as a single engine and is made up with the same components making up a stand-alone engine in the conventional propulsion module. The difference between the two systems is as follows: in the conventional system, when a component fails, the complete stand-alone engine is shut down along with all its related components; e.g, if instrumentation senses an impending bearing failure in the pump, not only does the turbopump shut down, but the thrust chamber, heat exchanger, controller, etc., on the engine also are totally shut down. In the integrated system, if a component fails, it is isolated from the system and does not shut down other components in the system. In effect, we simply have a "component-out" capability.

The component-out capability of the integrated system can be illustrated with the simple system schematic shown in Figure 1-20. When there is a thrust chamber failure, isolation valves will shut the component off from the rest of the system and the remaining thrust chambers supplied by the propellant manifold continue to operate. When there is a potential turbopump failure, isolation

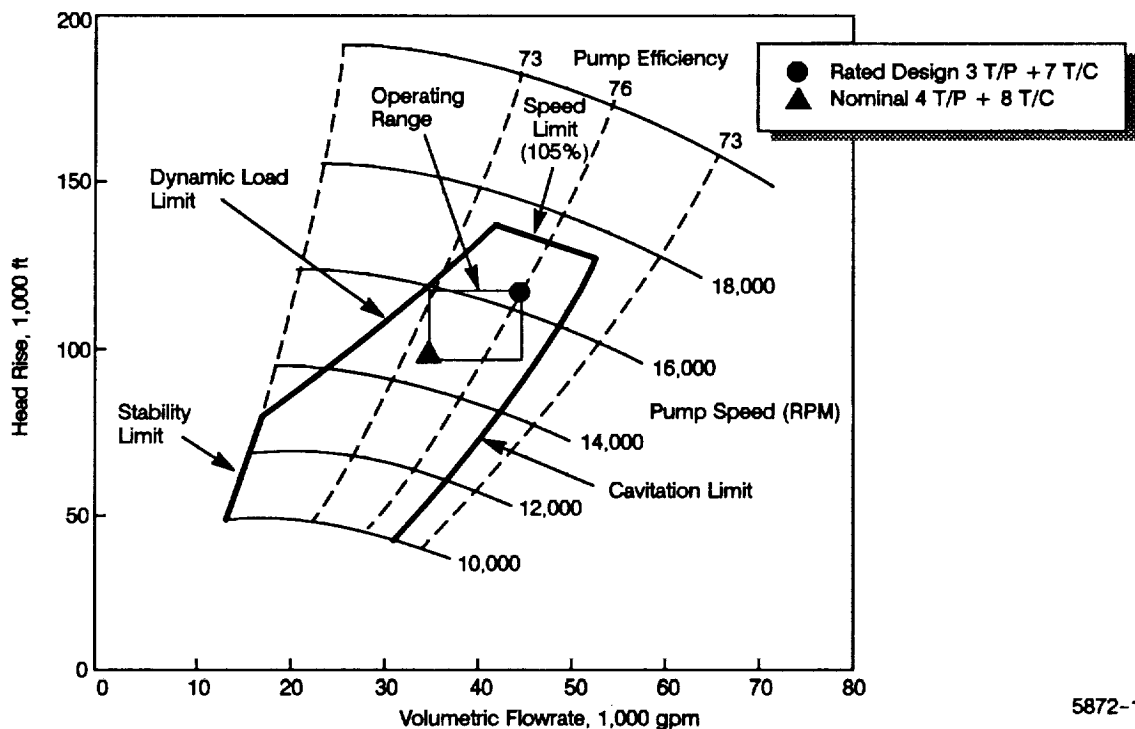

5872-14

Figure 1-18. LH<sub>2</sub> Pump Performance Map

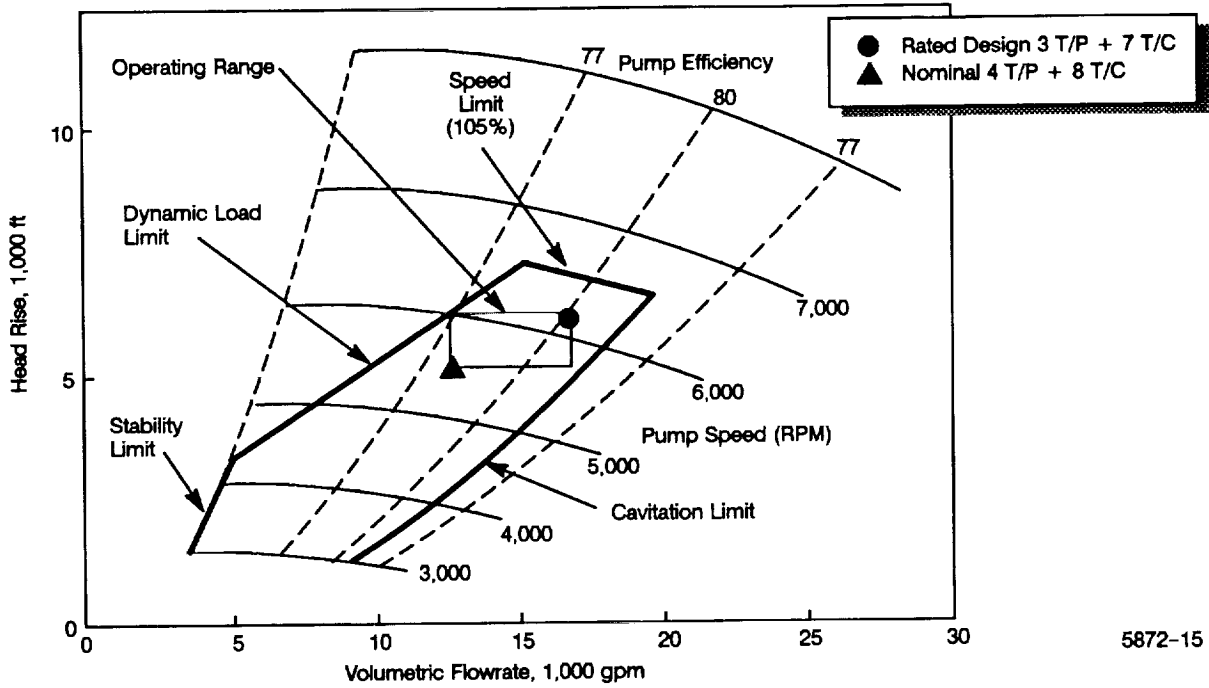

5872-15

Figure 1-19. LOX Pump Performance Map

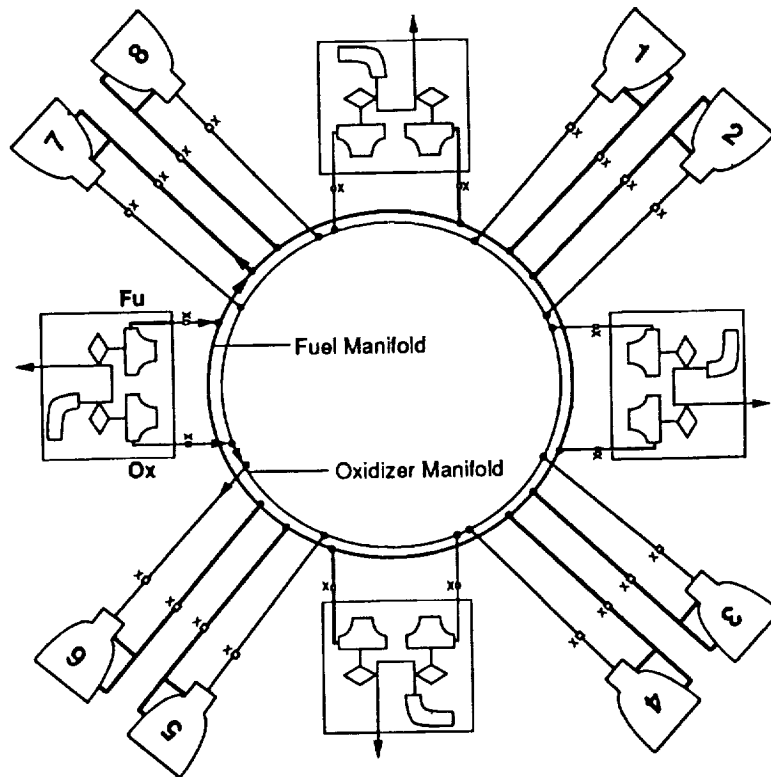

Figure 1-20. Simplified Integrated System Schematic

valves will shut off the turbopump from the system and the remaining turbopumps will continue to supply propellants to the manifold.

For the ALS booster utilizing the integrated system, the normal operation of all thrust chambers are at 85% rated thrust. When there is a thrust chamber-out, the remaining seven thrust chambers are throttled up to 100% rated thrust. Similarly, with an integrated system the normal operation of all turbopumps are at 90% rated speed. When there is a turbopump-out, the remaining three turbopumps are throttled up to 93% rated speed. If both thrust chamber-out and turbopump-out conditions occur, then the remaining thrust chambers and turbopumps will throttle up to 100% rated thrust and speed, respectively. Table 1-4 summarizes the component-out capability of the integrated system. For any component-out conditions the turbopumps operate well within the performance limits as illustrated in Figure 1-21. The turbopump operating speeds at nominal (90%) and component-out conditions (100%) are shown in Table 1-5.

The conventional seven stand-alone engine booster (Figure 1-3) cannot tolerate an independent failure of both a thrust chamber and a turbopump (resulting in two engine out) without losing vehicle mission. On the other hand, under identical failure conditions, the integrated system will allow the vehicle to complete its mission and therein lies the unique advantage of the integrated system.

The thrust chamber-out capability also exists for the integrated core propulsion module. When there is a thrust chamber-out, the remaining three thrust chambers throttle up to 100% rated thrust. When turbopump-out occurs, both the remaining core thrust chambers and all booster thrust chambers and turbopumps will throttle up to 100% rated thrust and speed. Herein lies the robust design, operating margin, reliability, redundancy and failure tolerance achieved by the integrated propulsion system.

**Table 1-4. Component-Out Operating Conditions**

<b>Engine Operation</b>	<b>Thrust Chamber (T/C) % Rated Thrust</b>	<b>Turbopumps (T/P) % Rated Speed</b>
Nominal	85	90
T/C - Out	100	97
T/P - Out	85	93
T/C and T/P-Out	100	100

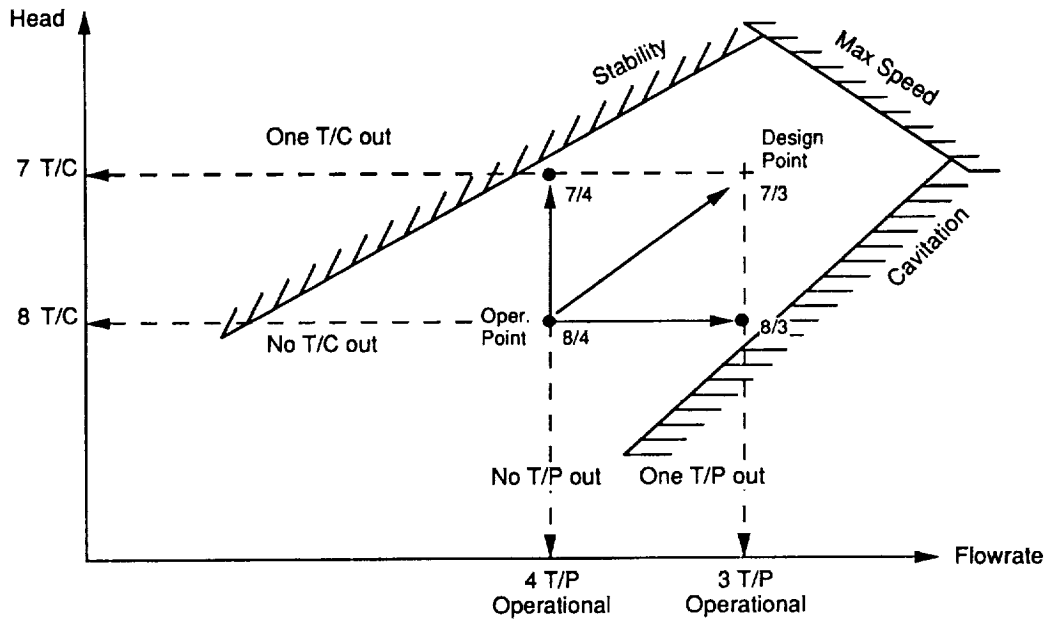

**Figure 1-21. Turbopump Operating Margin**

**Table 1-5. Turbopump Operating Speeds**

Booster	7-engine (7-T/P)	8-thrust chamber (4-T/P)	
	Des. RPM (100%)	Des. RPM (100%)	Oper. RPM (90%)
LH2-Turbopump	26,000	16,300	14,700
LO2-Turbopump	10,000	6,200	5,500

### 1.4.3 System Start and Shutdown

A fluid dynamic digital transient model is being developed to simulate the integrated BPM system start and shutdown behavior and transients associated with thrust chamber-out and turbopump-out. The model simulates the eight STME thrust chambers and four scaled-up STME turbopump sets. Each pump and gas generator are designed for twice the flow of the STME pump and gas generator. Under normal operation, the eight thrust chambers operate at 85% of rated thrust, and the four turbopumps operate at 90% of rated speed. Use of the toroidal propellant feed manifolds common to the eight thrust chambers and four turbopumps, permit a failure of either one thrust chamber, one turbopump, or both thrust chamber and turbopump without system shutdown. In case of a component failure, the remaining components can be powered up to their rated design operating levels to compensate for the losses. The following criteria will be used in selecting a start/cutoff sequence: (1) maintaining a fuel-rich environment in the gas generators and main thrust chambers during start and shutdown to avoid damage to both the turbine blades and combustion chambers; (2) avoiding a stall condition in the fuel pumps during start; and (3) avoiding propellant boil-out in the fuel pumps during cutoff which could damage pump bearings.

As seen in Figure 1-20, the integrated BPM may be envisioned as four subsystems (or engine-elements) where each subsystem is comprised of a fuel and an oxidizer turbopump powered by a gas generator, eight valves and two thrust chambers interconnected by ducts and fuel/oxidizer manifolds. The eight valves consist of pump valves, gas generator valves, and thrust chamber inlet valves shown in Figure 1-15. Each engine subsystem is configured as a gas generator cycle. The initial model simulation will use a hydrogen spin start to obtain a simultaneous start of all gas generators. Subsequent simulation will use a hydrogen spin start for one subsystem, and the gas generators for the remaining three subsystems will start off the pressurized ring manifolds.

Various information is required as input data for the model. The data in Table 1-3 was used for steady-state engine design balance. The valve characteristics are the same as those used in modeling the pump discharge valves, gas generator valves, and thrust chamber valves on the STME engine. The pump performance maps shown in Figures 1-18 and 1-19 were obtained by using the gas generator model for the STME.

The dynamic model for the integrated system is comprised of separate subroutines describing the fuel and oxidizer feed systems, the gas generator, and the main combustion chamber dynamics. These subroutines describe the dynamics of the basic components such as the pumps, turbines, valves, gas generator, combustor, and interconnecting ducts. The design data discussed above are inputs to these subroutines. The computer model for the integrated system is shown in Figures 1-22 and 1-23. Simulation computer runs yielding engine model conditions at steady state, which are in close agreement with the engine design conditions (Table 1-3), serve as an indicator that the model logic describes the engine dynamics accurately. Once this is accomplished, the computer model is ready for use. To investigate the dynamics of the integrated system for start, shutdown, or component failure, the engine model will be iterated, as illustrated in Figure 1-23, to determine the valve control sequence that would result in acceptable transient behavior.

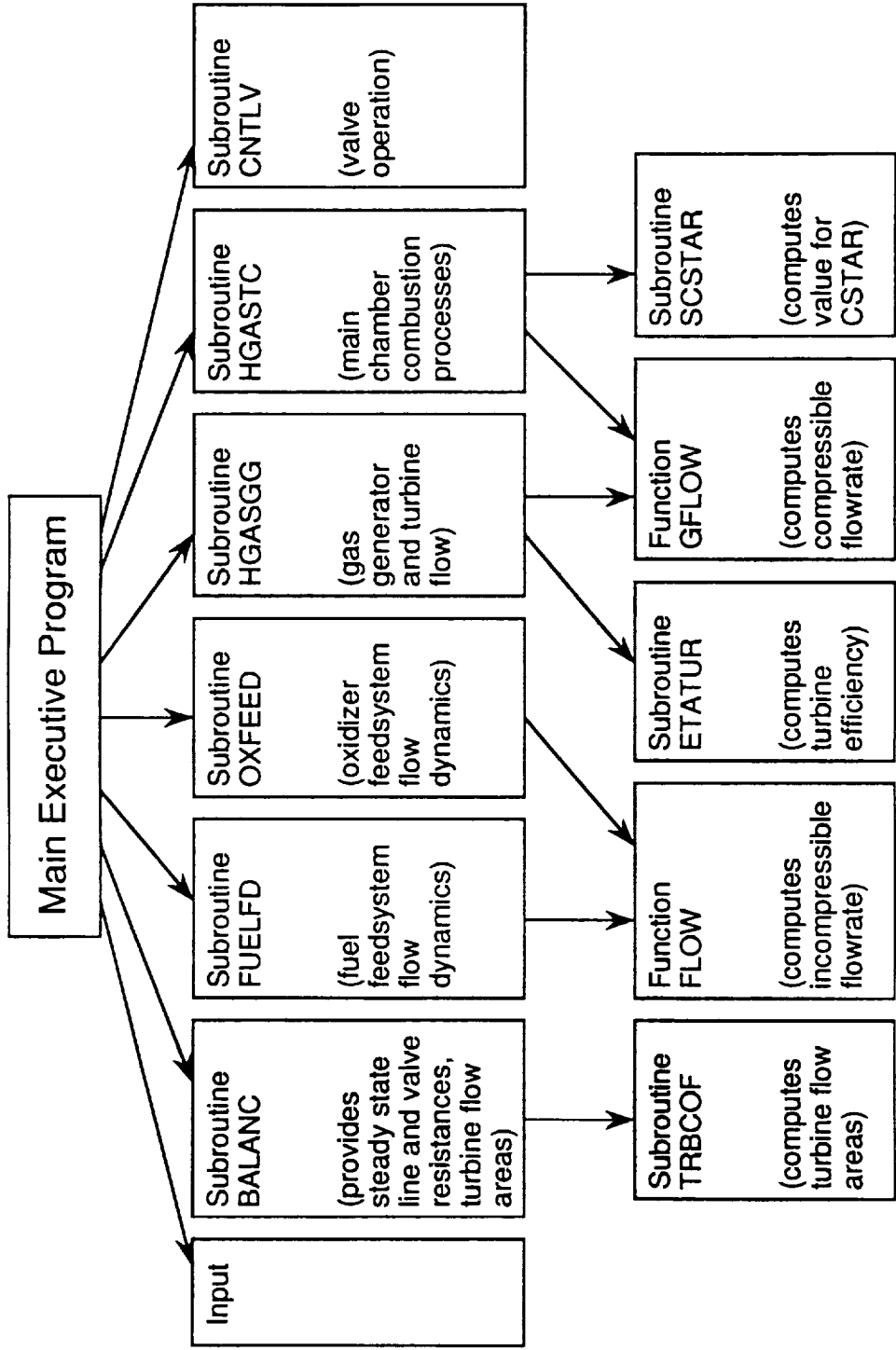

Figure 1-22. Transient Model Primary Programming Modules

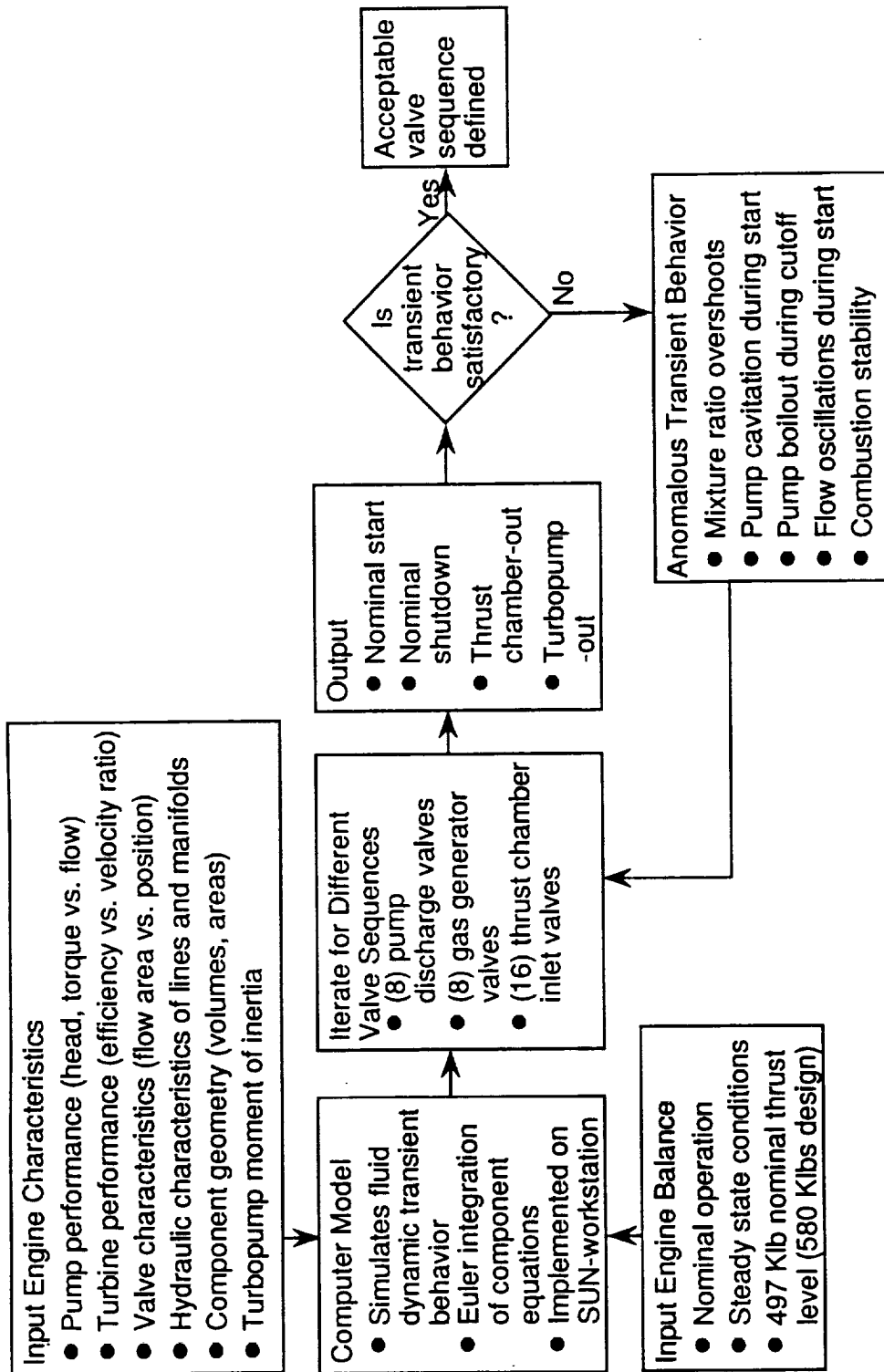

Figure 1-23. Methodology for Transient Simulation Modeling



#### 1.4.4 Avionics System

There has been considerable improvement in the avionic systems over existing systems in the past several years. Typical problems today like troubleshooting, software changes, little to no mass storage margin, nonstandard components, slow system response, and interfacing between engine controllers and the vehicle computer, dictated the use of a single controller–distributed system architecture approach. Most of these problems can be eliminated by incorporation of a single controller for the entire integrated BPM by modern technology, and by the use of an autonomous test and checkout system. The features of the avionics system for the integrated BPM are given in Table 1–6.

The integrated BPM avionics consist of the following elements: tracking (beacon and antenna), range safety, electrical power and distribution (batteries), instrumentation, and data processing (electronic control unit, software and driver electronics). The avionics are defined in Figure 1–24 and the functions of the electronic controller are essentially: (1) system checkout; (2) fault detection; (3) fault isolation; (4) fault reconfiguration; (5) receive instrumentation data for control input; (6) sequencer (open/close valves, etc.) for system operation; and (7) provide communication with the booster and core vehicle. Additional software functions are defined in Table 1–7.

Using a single, dual redundant controller is an option that makes considerable sense for a fully integrated propulsion module. Assuming the control function for the entire module resides with this controller, a single box is all that is required. This eliminates hardware like the Shuttle EICs and

**Table 1–6. Integrated BPM System Features**

<b>System Features</b>
• Single BPM Controller
• Automated Test & Check Out Capability
• Distributed System Architecture
• Dual Mode: Regular and Periodic Mode
• Redundant Power Supplies - MIL-STD-1539
• Low Wattage Dissipation
• Voltage Reg, Filtering, and Electromagnetic Interference Protection
• Two Redundant Data Channels for I/F to Data
• Instrumentation, Cal and Checkout performed by Internal BITE capability
• Standard Interface Units to minimize wiring
• Higher Level Software Language

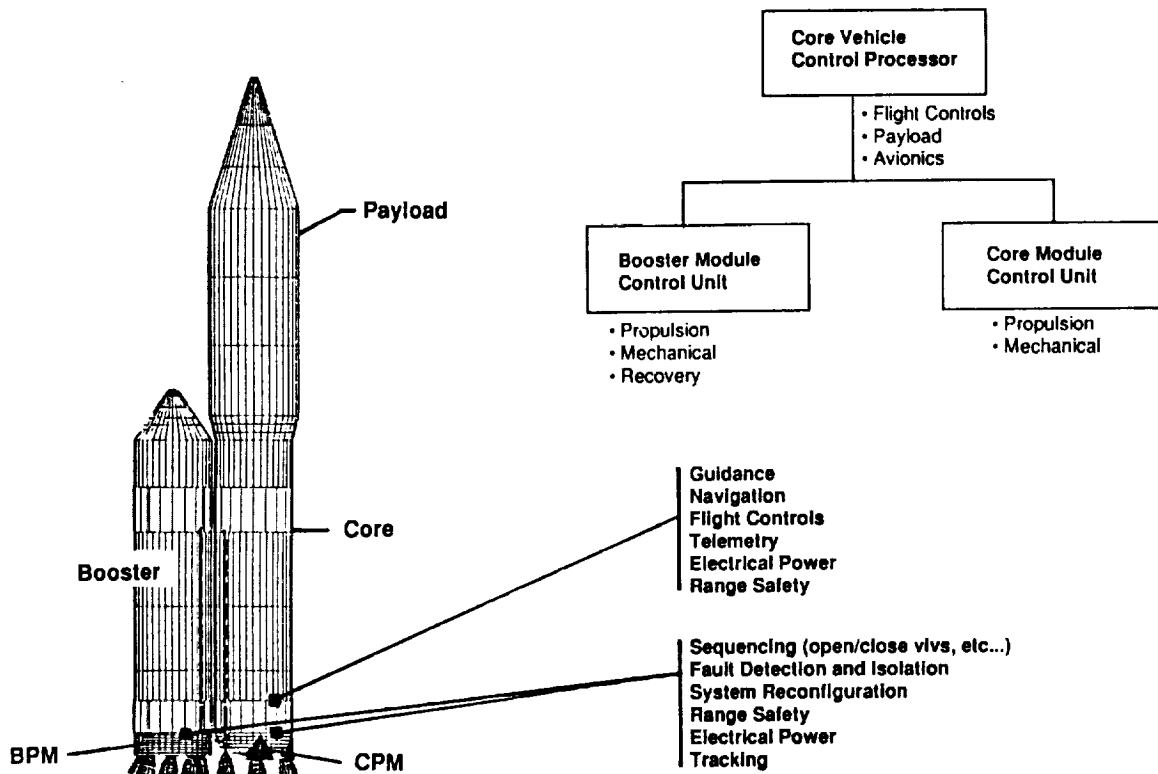

**Figure 1-24. Integrated BPM Avionics Definition**

main engine controllers for each engine. The box is dual redundant (pair of self-checking pairs) and would be connected to a standard multiplexing bus (MIL-STD-1553) with two channels: A and B. By use of today's computer technology many of the current software problems just will not exist. Today's computers are more reliable, have magnitudes more memory, can handle high level programming languages, have high data transfer rates, lower power requirements, and are considerably smaller in physical size compared to the hardware used in the Shuttle. Problems like not being able to load up new code before downloading the old code or verifying flight and checkout software changes are essentially eliminated or automatically done by the system itself.

Instead of manually checking each connection, valve cycle, etc., the controller with an autonomous check-out capability, or built-in test (BIT), will provide a checkout of the entire system down to the LRU level. The controller has two modes: initial checkout (for ground checkout and health status) and periodic checkout (for flight health status). Upon completing the ground checkout, the controller can be connected to a ground printer for fault identification and maintenance action.

### 1.5 THRUST VECTOR CONTROL

The thrust vector control (TVC) system for a launch vehicle has been a major operations problem for multiple engine systems, especially if the design requires TVC for each engine. Engine gimbaling greatly complicates the vehicle design by requiring hydraulic gimbal actuators, complex flexible inlet feed duct assemblies, sophisticated heat shields, and hydraulic or electrical power to drive the gimbal actuators. Current launch vehicles which use hydraulic actuators are considered

**Table 1-7. Integrated BPM Typical Electronic Controller Function**

<b>Software Functions</b>	
• Task Scheduling	• System Initialization
• Interrupt Handling	• Power Monitoring
• Sleep Mode Activation	• Interface
• Engine-Vehicle Communications	• GSE Interface
• Interchannel Communications	• Controller Diagnostics
• Sensor Calibration	• Signal Condition Checkout
• Status readout to Core Vehicle	• Watchdog timer Control
• Ensure Fail-Op/Fail Safe Operation	• Automatic Redundant Channel Selection
• Closed or Open loop Control	• Engine Monitor Data Collection
• Identifies Hazards	• Identifies Correctable Failures
• Identifies Maintenance Actions	• Maintains Failure/Maintenance Data Base
• Engine Valve Timing	• TVC
• Provide Communication with Core	• Accept Commands from Core Transmit
• Performance and Health Data	• Perform Fault Isolation & Reconfiguration
• Thrust Control (+/- 2%)	• Mixture Ratio Control (+/- 2%)
• Health Monitoring	
• Throttling (Accel Schedule, Decel Schedule)	
• Provide Valve Sequencing (Start & Shutdown)	

operational “nightmares” since the ground operational personnel not only have to check out and verify every valve, pump, and fitting on the flight vehicle, but the hydraulic system dictates ground facilities usually more complex than the flight system, that also must be maintained, checked out, and serviced (see OEPSS Databook Volume II—Ground Operations Problems.)

To illustrate that an operationally simple static booster propulsion system is viable, even for a side-mounted stage and a half booster vehicle, the ability of an integrated core propulsion module (Figure 1-6) providing conventional thrust vector control was briefly investigated. (Other TVC options that could be used are presented in Table 1-8.) For core gimbaling, electromechanical actuators (EMAs), which are simpler to install, check out, and maintain, should be used.

**Table 1-8. Thrust Vector Control Options**

<b>Approach Options</b>	<b>Issues</b>	<b>Recommendations</b>
1. Gimbal Booster Engines Gimbal Core Engines	<ul style="list-style-type: none"> <li>• Complexity</li> <li>• Cost</li> <li>• Reliability</li> </ul>	<ul style="list-style-type: none"> <li>• Acceptable</li> <li>• Evaluate cost and reliability issues</li> </ul>
2. Fix Booster Engines Gimbal Core Engines	<ul style="list-style-type: none"> <li>• Engine out</li> <li>• Large gimbal angles on core engines</li> </ul>	<ul style="list-style-type: none"> <li>• Acceptable for 4-engine core</li> <li>• Requires further evaluation for 3 engine core</li> <li>• Requires fixed engine cant</li> </ul>
3. Differential Throttle Booster Engines Gimbal Core Engines	<ul style="list-style-type: none"> <li>• Response time</li> <li>• Engine reliability</li> <li>• Engine cost</li> </ul>	<ul style="list-style-type: none"> <li>• Evaluate only if Option 2 not feasible</li> </ul>
4. Gimbal GG Exhaust Gimbal Core Engines	<ul style="list-style-type: none"> <li>• Complexity</li> <li>• Requires large thrust</li> </ul>	<ul style="list-style-type: none"> <li>• Evaluate only if Option 2 not feasible</li> </ul>

For the integrated booster and integrated core propulsion module configuration, flying the ALS trajectory at the worst case scenario of highest wind shear and engine-out condition shown in Figure 1-25, preliminary analyses indicates that by precanting the engines (i.e., thrust chambers) it is feasible to fix the booster BPM and gimbal the core CPM to provide adequate vehicle control during first and second stage flight. The driving factors are the max-Q, max-Alpha condition, the booster dynamics, and engine-out considerations.

The TVC gimbal angle requirement for no canting and using a precant angle of 10 deg for the booster engines is shown in Figure 1-26. By using a precant angle of 10 deg for the booster engines and a precant angle between 5 and 10 deg for the core engines, the core engine gimbal angle required is approximately 7 to 9 deg at maximum aerodynamic condition and 10 to 12 deg at engine shutdown and stage separation. This is shown in Figure 1-27. These gimbal angles are very close to those required for conventional engines. Other vehicle designs that are more symmetrical (than the side-mounted vehicle) with equal thrust on each side of the core vehicle will have simpler gimbaling requirements.

## **1.6 RELIABILITY, OPERABILITY, AND COST**

The purpose of this study was to illustrate by example how operations problems can be eliminated at the conceptual design level by reducing the number of components in the system and thereby simplifying the operational complexity and operations support. To the extent this was achieved with a fully integrated system, the results will be compared to a typical conventional propulsion system using a cluster of stand-alone, autonomous engines shown in Figure 1-28. A common set of design parameters will be used for this comparison. Therefore, the only thing that is important in the design comparison is the “relative difference.”

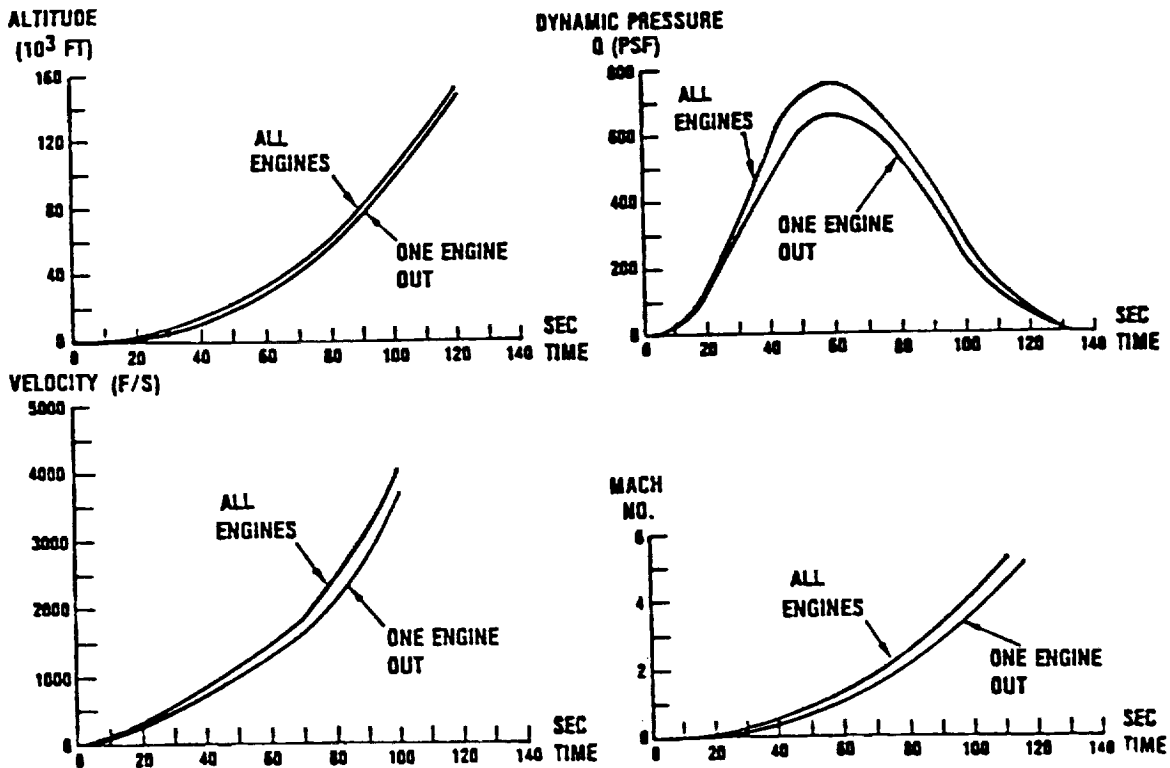
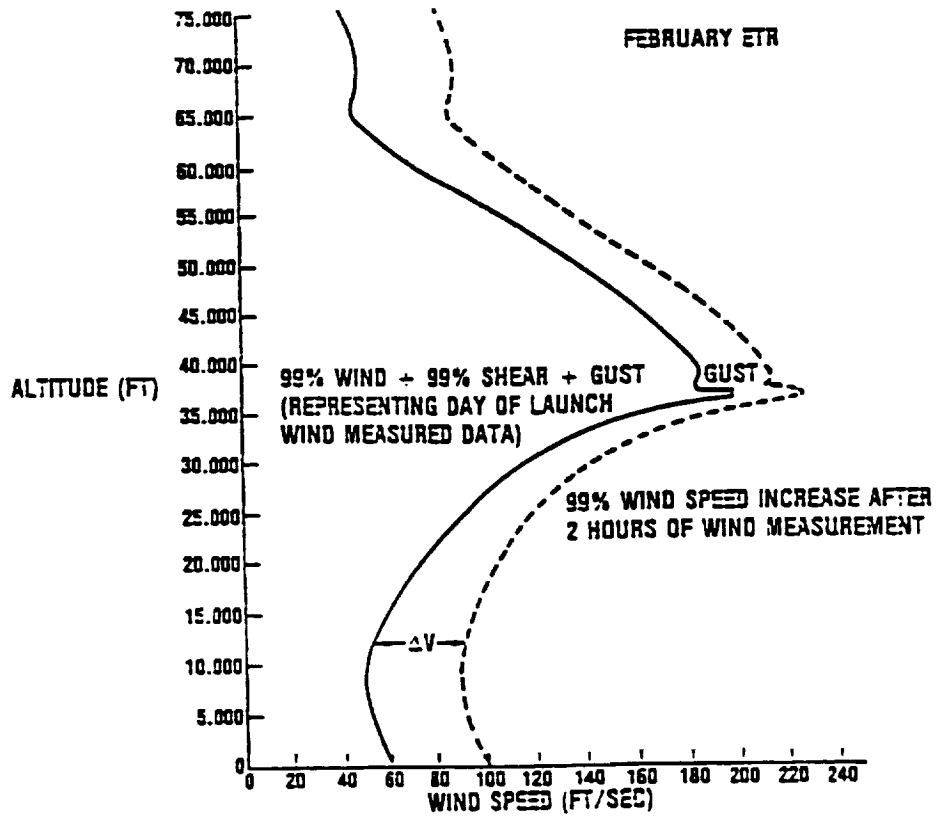

Figure 1-25. Parameters for Typical ALS Trajectory

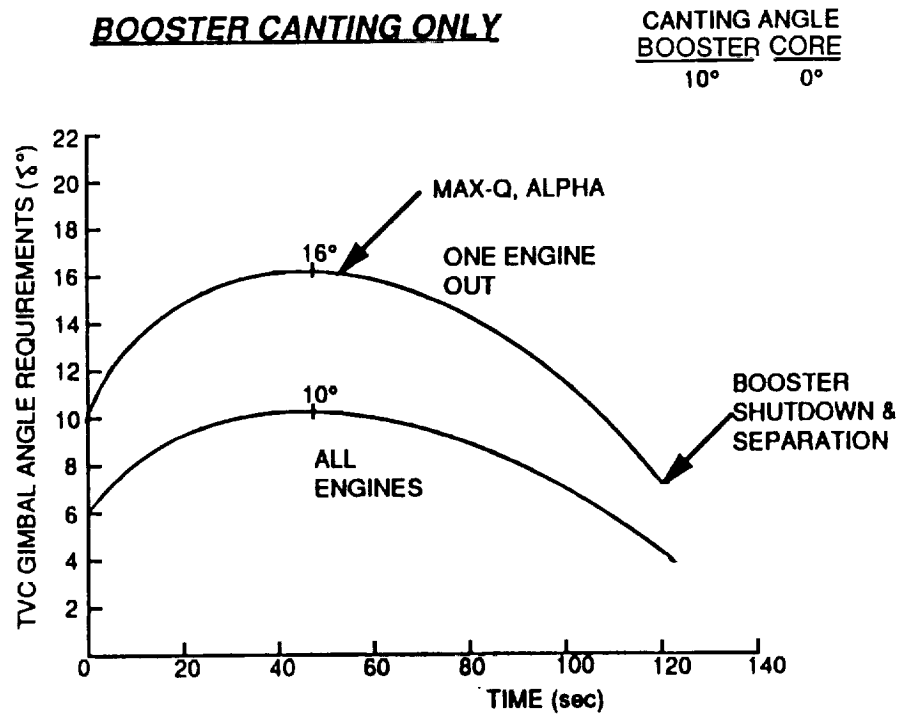
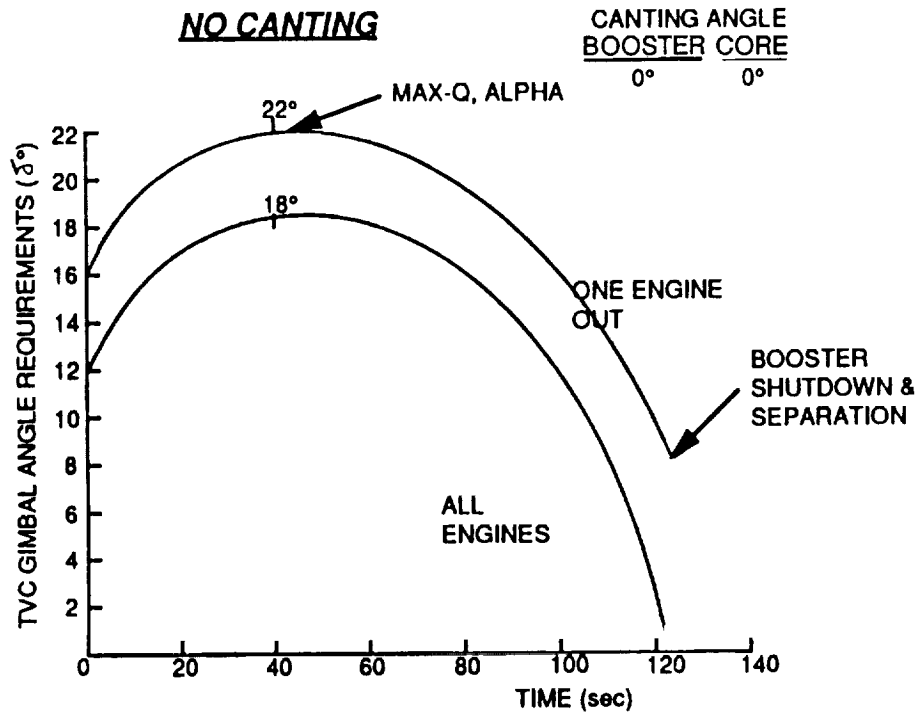
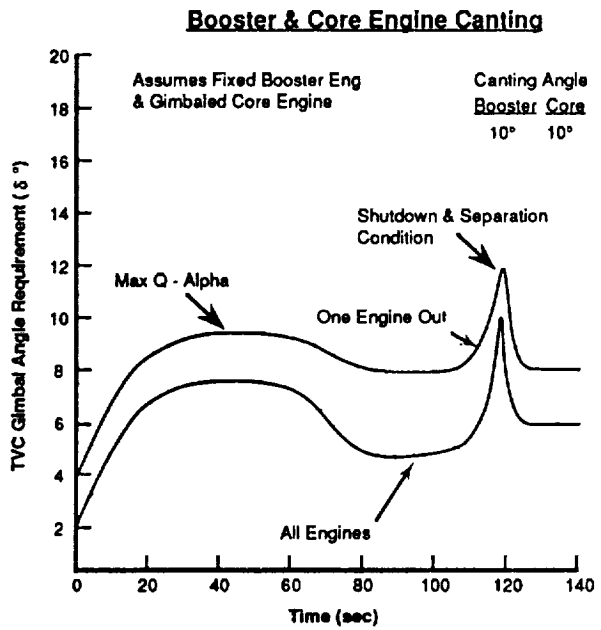
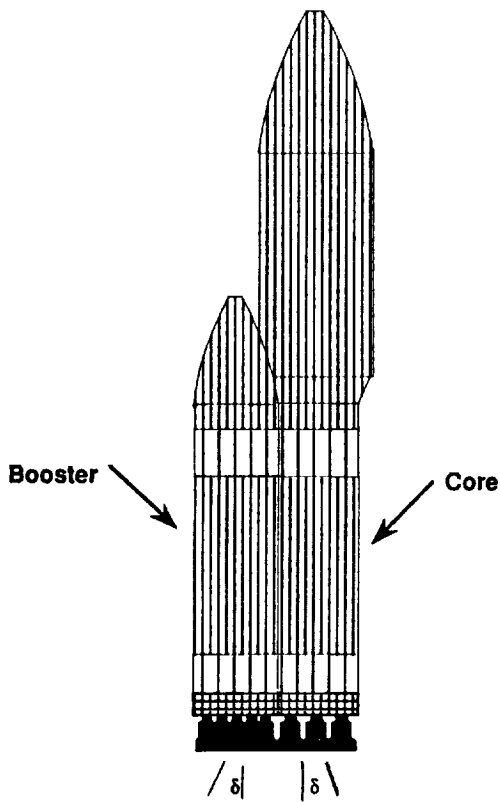

Figure 1-26. Core TVC Gimbal Requirements. No Canting and Booster Canting Only



Canting with core & booster engines allows a reasonable gimbal angle range

**Figure 1-27. Core TVC Gimbal Requirements.  
Combination of Core and Booster Canting**

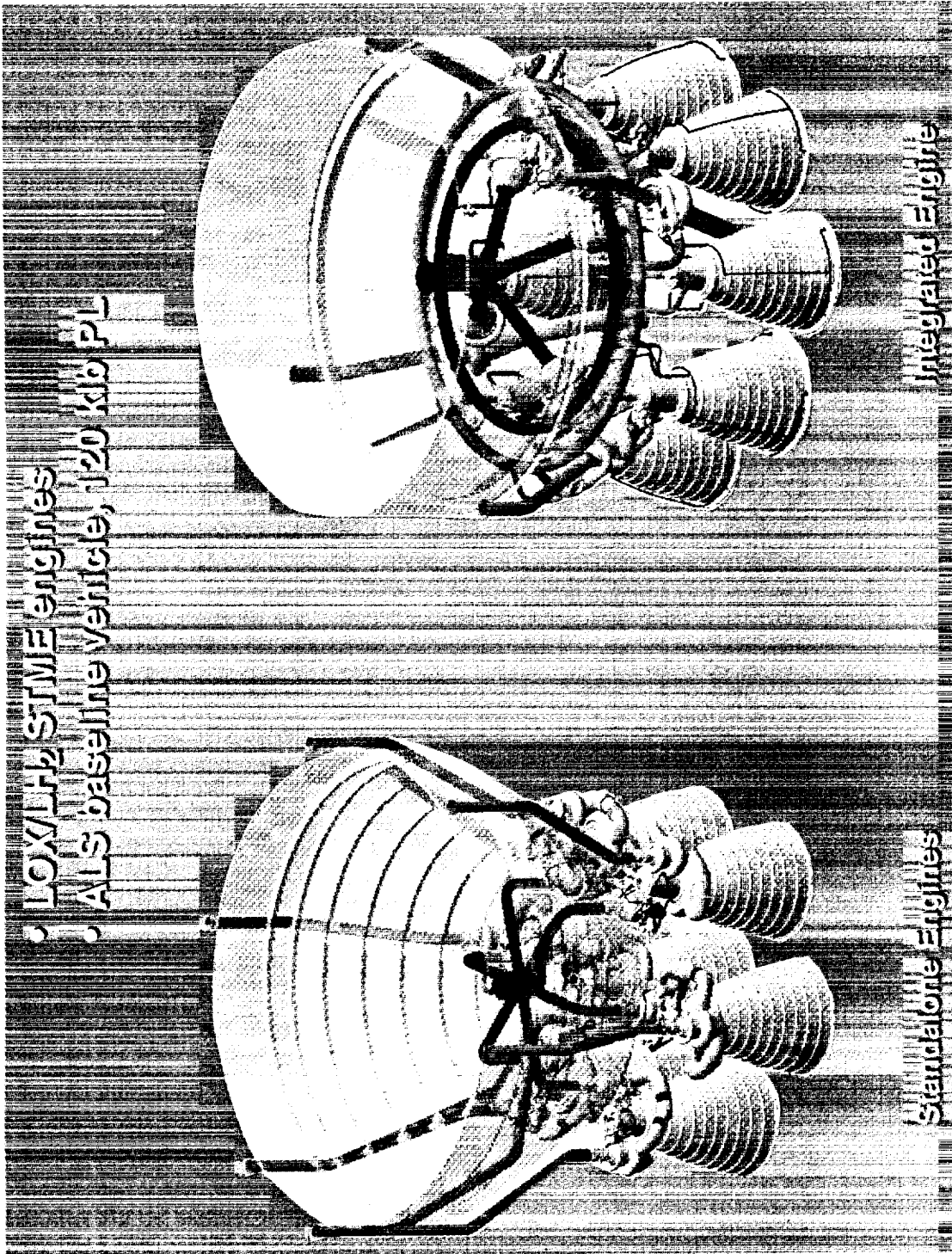

Figure 1-28. Comparison of Two Booster Propulsion System Designs



### 1.6.1 Design Simplicity

A simple schematic comparison of major components of the two propulsion systems is depicted in Figure 1-29 and itemized in more detail in Table 1-9. The system utilizing separate engines will require as many duplicate components as there are engines. The fully integrated system utilizes a parallel operating network to minimize the number of components needed to fulfill the same system functions.

As seen in Table 1-9, the integrated system has eliminated three turbopumps and five heat exchangers (a second heat exchanger was added to provide redundancy). Six controllers and PCAs have been eliminated and the controllers are replaced by a single controller with built-in fault tolerance and redundant avionics. Fourteen flexible inlet lines have been replaced by eight fixed inlet lines and 14 gimbal actuators are eliminated, both as a result of utilizing a static (non-gimbaling) booster. Fourteen prevalues have been eliminated; however, 10 simple isolation valves are added for subsystem isolation in the event of T/C-out or T/P-out. The integrated system requires two propellant ring manifolds but eliminates the center engine-mount system. The one added thrust chamber provides both design and operating margins (robust design). The larger (scaled-up) turbopumps (designed for 35% lower design speed and operating at 90% of the lower design speed) provide both turbopump design and operating margins (robust design). The turbopumps are separated from the thrust chamber and close-coupled to eliminate the turbine crossover ducts. Elimination of the center engine, feedline, and center mount also eliminates potential pogo problems.

The simpler design of the integrated system is seen to reduce the number of major components by approximately 33%. Since system complexity varies exponentially with the number of components and their interfaces, the operations cost would be reduced by as much as 66% or more, not including the advantages of reduced cost of launch delays or lost opportunities caused by complex systems.

With fewer components and interfaces achieved by the integrated system, together with greater design margin, operating margin, and redundancy achieved by its components operating in a parallel system, the operational efficiency and operability achieved by the integrated system is clearly evident.

### 1.6.2 Comparative Reliability

The reliability of the integrated propulsion system was obtained by using the components presented in Table 1-9 and the equivalent component reliabilities used for the STME engine. As seen in Table 1-10, the integrated system achieved a higher basic system reliability of 0.9935 over that for the conventional system of 0.9889. Perhaps the greater advantage of the integrated system is its system reliability with engine-out capability. This will be illustrated by using the simple propulsion system schematic shown in Figure 1-29.

For the conventional system of single engines, a component failure in a single-string system will shut down all the good components along with the failed component. For the integrated system, a component failure will be selectively isolated and all remaining components will continue to operate

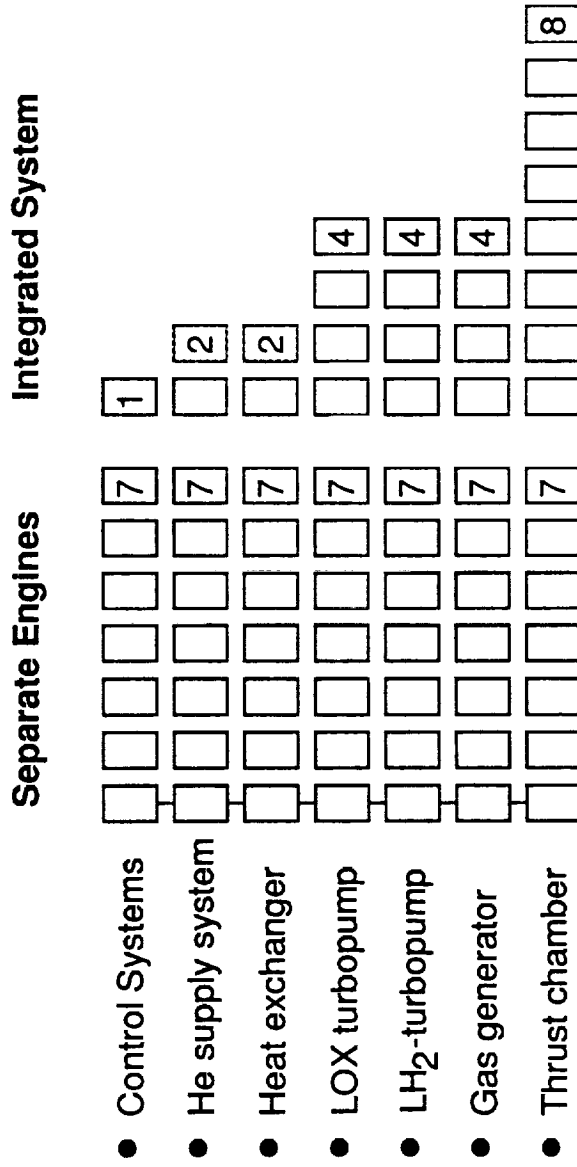

Figure 1-29. Schematic Comparison of Two Booster Propulsion System Designs

**Table 1-9. Booster Propulsion Module Hardware Comparison**

Engine Elements	Separate Engines	Integrated System (Static)
	No. of Components	No. of Components
Thrust chamber:		
MCC	7	8
Injector	7	8
Nozzle	7	8
Igniter	7	8
Oxidizer turbopump	7	4
Fuel turbopump	7	4
Gas generator	7	4
Heat Exchanger	7	2
Start System	7	1
PCA	7	1
Controller (avionics)	7	1
Gimbal bearing	7	0
Gimbal actuator	14	0
Propellant lines	14	4
Flexible inlet lines	14	0
Fixed inlet lines	0	8
Main valve/actuator	14	24
Prevalves	14	0
Crossover duct/lines	7	0
HP T/P discharge lines	0	8
Ring manifold	0	2
HP T/C inlet lines	0	8
Miscellaneous	7	8
Center engine mount	1	0
<b>Total</b>	<b>169</b>	<b>111</b>

(see Section 1.4.2). For the conventional system, if an independent thrust chamber (T/C), and an independent turbopump (T/P) fail, in all probability, this will shut down two engines and will result in mission loss for the vehicle. On the other hand, for the integrated parallel system, the independent failure of a thrust chamber and a turbopump will result in the isolation of only the failed components while all remaining good components continue to operate and achieve vehicle mission. In other words, with independent T/C-out and T/P-out capability (which a conventional system cannot meet), the integrated system achieves an even higher system reliability of 0.9990; whereas, the reliability would be zero for the conventional system.

### 1.6.3 Comparative System Cost

For the ALS mission model, the recurring unit production cost for the integrated system was determined by applying the component unit costs estimated for the STME engine. Components unique to the integrated system, such as manifolds, were conservatively estimated. The higher cost for the larger turbopumps and heat exchangers also were estimated, and in general a single large unit

Table 1-10. Booster Propulsion Module Reliability Comparison

Engine Elements*	Component Reliability	Separate Engines		Integrated system	
		No. of Components	Subsystem Reliability	No. of Components	Subsystem Reliability
Thrust chamber assy	0.99978	7	0.99846	8	0.99824
T/C ISO valve, ox	0.99996	0	-	8	0.99968
T/C ISO valve, fuel	0.99996	0	-	8	0.99968
Oxidizer turbopump	0.99986	7	0.99902	4	0.99944
Fuel turbopump	0.99972	7	0.99804	4	0.99888
MOV	0.99996	7	0.99972	4	0.99984
MFV	0.99996	7	0.99972	4	0.99984
Gas generator	0.99983	7	0.99881	4	0.99932
PCA	0.99999	7	0.99993	1	0.99999
Controller	0.99996	7	0.99972	1	0.99996
Gimbal system	0.99999	7	0.99993	0	-
Heat exchanger	0.99989	7	0.99923	2	0.99978
Propellant lines	0.99999	14	0.99986	4	0.99996
Inlet line, flex	0.99980	7	0.99860	0	-
Inlet line, fixed	0.99980	7	0.99860	4	0.99920
Prevalve, oxid	0.99996	7	0.99972	0	-
Prevalve, fuel	0.99996	7	0.99972	0	-
Crossover duct	0.99980	7	0.99860	0	-
HP T/P discharge lines	0.99999	0	--	8	0.99992
Ring manifold	0.99991	0	-	2	0.99982
HP T/C inlet lines	0.99999	0	-	8	0.99992
Overall reliability		0.98775		0.99351	

\*STME Components

performing the equivalent function of several smaller units will be lower in cost and lighter in weight than all the smaller units. As seen in Table 1-11, the integrated system was found to achieve a 22% lower total system cost over the conventional system. On another basis, the integrated system achieved a unit cost of \$1.8M on a thrust chamber basis, or a unit cost of \$2.09M on an equivalent stand-alone engine basis, compared to the estimated conventional engine cost of 2.67M. Simply put, given the lowest cost conventional system, this cost can be lowered even further by integrating the same system.

#### **1.6.4 Comparative System Weight**

Similar to the approach taken for estimating system cost, the system weight of the integrated system was determined by using component unit weights estimated for the STME engine. Engineering estimates were used for the manifolds. The thrust structure weights were not included in the example study and are both assumed to be closely the same. Based on the results shown in Table 1-12, the integrated system weight is estimated to be 13% lower than the conventional system weight.

### **1.7 OPERATIONS MUST DRIVE CONCEPTUAL DESIGN**

Today's launch systems have resulted in high operations cost and low flight rates. Complex systems have been found to be the cause for the inordinate time and manpower needed to meet ground processing operations and for our inability to achieve routine space flight. The complex propulsion system for our current launch systems has been a major part of this problem. In order for future advanced launch vehicles, such as the ALS, to deliver payload to orbit (LEO) at lower cost and higher flight rates, the design of the propulsion system must be greatly simplified and made more operationally efficient.

The example used in the study clearly demonstrates the substantial promise and potential of an integrated propulsion system approach to eliminate operations problems and achieve operational efficiency. As shown in Table 1-13, the integrated system has the following potential design and operational advantages:

- Design simplicity
- Higher reliability
- Greater engine-out capability
- Operating margin
- Robustness
- Increased operability
- Lower operations cost
- Potential for lower system cost and weight

Table 1-11. Booster Propulsion Module System Cost\*\*Comparison

Engine Elements	Unit Cost \$K	Separate Engines		Integrated System	
		No. of Components	Cost \$K	No. of Components	Cost \$K
Thrust chamber: MCC	370	7	2590	8	2960
Injector	192	7	1344	8	1536
Nozzle	306	7	2142	8	2938
Igniter	31	7	217	8	248
Oxidizer turbopump	263	7	1841	4	1580*
Fuel turbopump	400	7	2800	4	2400*
Gas generator	29	7	203	4	116
Heat Exchanger	79	7	553	2	316
PCA	220	7	1540	1	220
Controller (avionics)	96	7	672	1	304
Gimbal bearing	71	7	497	0	0
Gimbal actuator	30	14	420	0	0
Propellant lines	21	14	294	4	84
Flexible inlet lines	18	14	252	0	0
Fixed inlet lines	12	0	0	8	96
Main valve/actuator	35	14	490	24	840
Prevalves	21	14	294	0	0
Crossover duct/lines	166	7	1162	0	0
HP T/P discharge lines	6	0	0	8	48
Ring manifold	100	0	0	2	200
HP T/C inlet lines	6	0	0	8	48
Miscellaneous***	--	--	1767	--	712
<b>Total Cost, \$</b>			<b>18,861,000</b>		<b>14,646,500</b>
<b>Cost per Engine, \$M</b>			<b>2.69 ****</b>		<b>1.83</b>

\* Cost factor for regen T/C T/P and HX: 1.2, 1.5 and 2.0

\*\* 500th unit cost

\*\*\* 10% separate; 5% integrated

\*\*\*\* Basic STME \$2.67M

**Table 1-12. Booster Propulsion Module System Weight Comparison**

Engine Elements	Unit Weight Lbs	Separate Engines		Integrated System	
		No. of Components	Weight Lbs	No. of Components	Weight Lbs
Thrust chamber:					
MCC	613	7	4291	8	4904
Injector	364	7	2548	8	2912
Nozzle	2088	7	14616	8	16704
Igniter	31	7	217	8	248
Oxidizer turbopump	1726	7	12082	4	9664 (1)
Fuel turbopump	1421	7	9947	4	7960 (1)
Gas generator	121	7	847	4	484 (2)
Heat Exchanger	101	7	707	2	404 (3)
Start System	35	7	245	1	70 (3)
PCA	82	7	574	1	82
Controller (avionics)	20	7	140	1	20
Gimbal bearing	158	7	1106	0	0
Gimbal actuator	190	14	2660	0	0
Propellant lines	--	14 (1186)	16600	4 (1587)	6348
Flexible inlet lines	734	14	10276	0	0
Fixed inlet lines	668	0	0	8	5344
Main valve/actuator	144	14	2016	24	3456
Prevalve	75	14	1050	0	0
Crossover duct/lines	214	7	1498	0	0
HP T/P discharge lines	360	0	0	8	2880
Ring manifold	3750	0	0	2	7500
HP T/C inlet lines	300	0	0	8	2400
Miscellaneous	585	7	4095	8	4680
Center engine mount	1826	1	1826	0	0
<b>Total Weight</b>			<b>87,340</b>		<b>76,058</b>

(1) Factor of 1.4; (2) Factor of 1.5; (3) Factor of 2.0

**Table 1-13. Integrated Propulsion Module Has High Reliability and Operability and Low Operations Cost**

Factor	Separate	Integrated
● Higher reliability	0.988*	0.993*
T/C and T/P out	0**	0.999**
● Lower engine (T/C) cost, \$M	2.67	1.83
● Less number of parts	169	111
● Lower potential weight, lbs.	87,340	76,058
● Lower operations cost	1	1/3

\* No engine-out capability      \*\* With T/C and T/P - out capability

The results of the example study summarized below revealed some clear guidelines that should be followed in developing operationally simple propulsion systems for future launch vehicles.

1. The major operations problems identified in the OEPSS study must be eliminated before any significant gains can be made to reduce today's complex operational requirements and high operations cost.
2. Many of these operations problems can be eliminated or mitigated by utilizing an integrated system approach and by applying operations technology identified by the OEPSS study.
3. To achieve an operationally efficient, low cost propulsion design, operations cost drivers must drive the initial design concept. A design that initially ignores operations problems cannot subsequently be made operationally efficient.
4. Propulsion system design for future launch systems can be made simpler and require less operations support by reducing the number of components and interfaces and by integrating the system functions. This is achieved by using the "integrated-component" design approach.
5. The integrated propulsion module engine, as an alternative propulsion concept for the ALS, illustrates the following point: given a propulsion system design using multiple autonomous engines, an integrated design of the same system will yield an equivalent system that will have substantially higher system reliability and lower system cost.
6. An integrated propulsion design can use existing technology, current ALS technology, or OEPSS technology to achieve greater operational efficiency.
7. An integrated design approach results in a propulsion design that is simpler, more reliable, more operable, lower cost than a conventional design and, therefore, eminently meets the ALS requirements for robustness, reliability, operability, low cost, and the ability to achieve high flight rates and, therefore, achieve routine access to space.



## **1.8 PAYLOAD CAPABILITY OF AN INTEGRATED PROPULSION SYSTEM**

In the description of the fully integrated propulsion concept for the ALS booster and core (Section 1.3), the “engine–element,” consisting of a turbopump set and two thrust chambers, is seen to be a basic building block for these propulsion systems. This basic engine–element, shown in Figure 1–30, can be used in any number to synthesize a propulsion system with the proper total thrust to deliver a corresponding payload to orbit. Thus, using a typical ALS family of launch vehicles illustrated in Figure 1–31, the building block engine–element can be used to synthesize a series of fully integrated propulsion modules with common baseline manifolds (for the BPM and CPM) to deliver a wide range of payloads from 60,000 lb to 300,000 lb to LEO. This is illustrated in Table 1–14.

The engine–element can also be used as a building block in the development program for an integrated propulsion system. While the development of a multiple–engine system begins with component development followed by engine development and main propulsion system (MPS) development, the development of the integrated propulsion module proceeds from component development to early engine–element system development (which includes the propellant feed system, pneumatics system, electrical power system, control system, etc.). This is directly followed by a short development of a well defined, integrated engine–element system package, such as the ALS booster (BPM) or core propulsion module (CPM). In the development of an integrated system there is potential savings in development hardware, testing, and schedule.



**Figure 1-30. Integrated Propulsion Module Engine-Element**

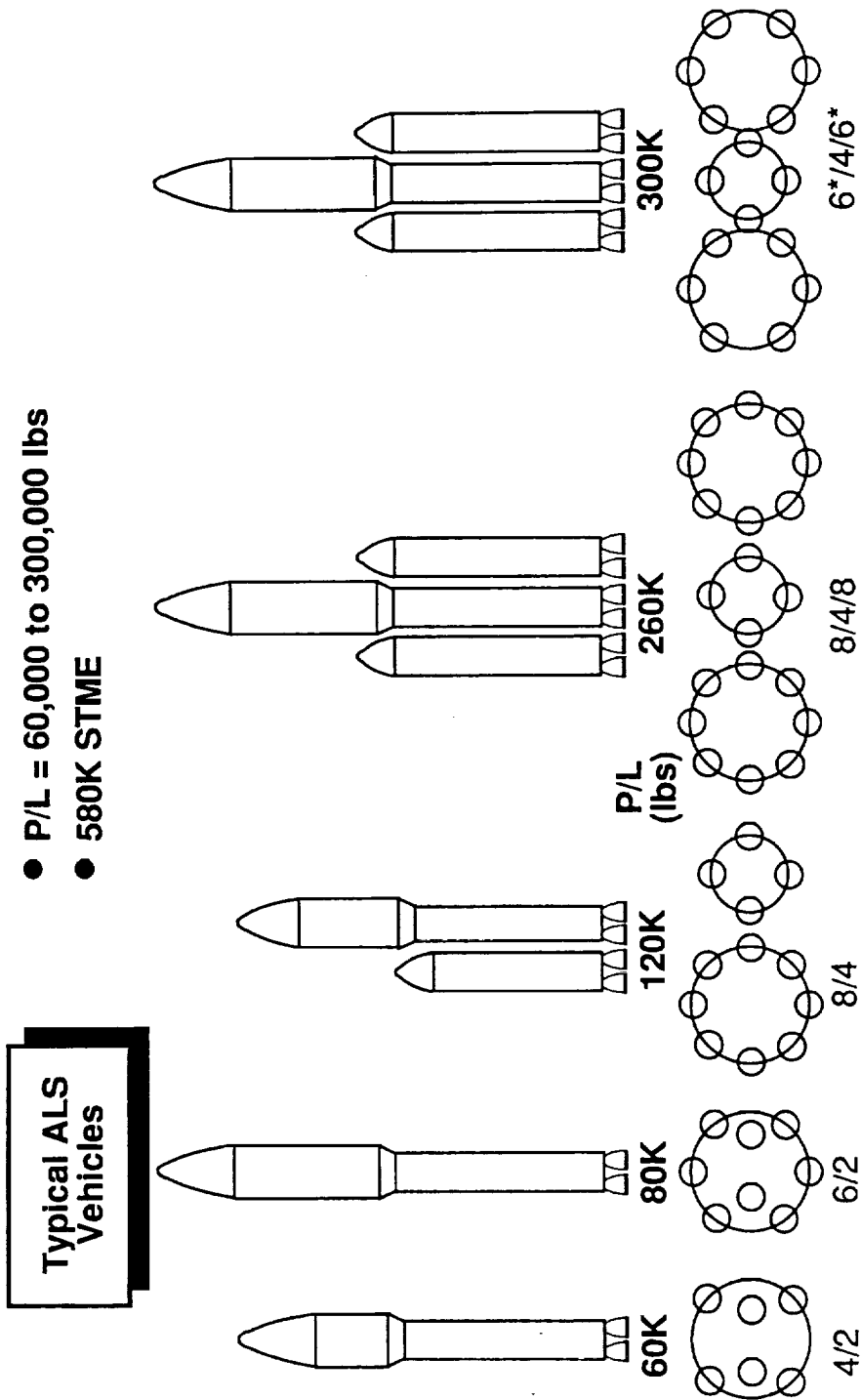

\* 650K STME

Figure 1-31. Typical Family of ALS Launch Vehicles

**Table 1-14. Payload Capability Using Integrated Engine-Elements**

- P/L = 60,000 to 300,000 lbs
- STME 580 Klbs thrust chambers

Integrated Engine:	Thrust Chambers		Payload Capability, lbs				
	Booster	Core	60K	80K	120K	260K	300K
3 - Elements*	4	2	X				
4 - Elements*	6	2		X			
6 - Elements**	8	4			X		
10 - Elements***	8/8	4				X	
8 - Elements****	6/6	4					X

- \* Staged vehicles
- \*\* Side-mounted booster vehicle
- \*\*\* Two side-mounted LRBs
- \*\*\*\* HLLV configuration, 650K STME

## 2.0 LOX TANK AFT PROPULSION CONCEPT

A launch vehicle with the main liquid oxygen tank located forward in the vehicle creates complex operational requirements and causes major operational problems or concerns that severely impact launch operations.<sup>1</sup> These problems include (1) geysering in the long propellant lines, (2) propellant conditioning to meet engine start requirements, (3) difficult checkout and servicing of long feed lines requiring a service tower, (4) higher ground transfer pressures for loading propellants to the elevated forward tank, and (5) operation of a helium-bubbling system to prevent geysering. These problems also create a need for a complex system of ground support facilities and personnel. Therefore, in the design of future launch systems, where the propellant tanks should be considered an integral part of the total propulsion system, alternative propellant tank concepts should be investigated that will either avoid or eliminate the serious operations problems described above.

### 2.1 TYPICAL PROPELLANT TANK CONFIGURATION

Hydrogen/oxygen launch systems, such as the ALS, typically have the LOX tank forward of the LH<sub>2</sub> tank and this is generally dictated by mass properties requirements, thrust vector control, and manufacturing cost.

Other vehicles, such as the Saturn I-C and the Shuttle external tank are also similar. Both propellant tanks are conventional configurations, with a cylindrical center section and forward and aft domes. A cylindrical intertank structure joins the two tanks. One or more LOX feed lines are routed from the aft end of the LOX tank around the LH<sub>2</sub> tank and to the main engine area. This configuration locates the vehicle center of gravity forward for good control moment for engine gimbaling and can minimize tank manufacturing costs. The baseline ALS vehicle used as a basis of comparison in this study is shown in Figure 2-1. It consists of a booster stage and core stage, with each stage having propellant tankage of the same size and configuration as shown.

### 2.2 OPERATIONS PROBLEMS

The following is a description of some of the major operations problems arising from the LOX tank forward configuration.

#### 2.2.1 Geysering

The high potential for geysering in the oxygen feed line is perhaps the most serious of the operational concerns, since catastrophic failure can result. Although it can occur and is of concern during low flow conditions, it is when flow is stopped that the geysering potential is highest. This condition can exist during any stop flow during propellant loading, after loading and before engine start, and during a hold or pad abort.

The geysering phenomena results when heating of the lower portion of the cryogenic feed line causes vaporization of the liquid. As the resulting bubbles rise, they expand, eventually coalescing into a single entity called a Taylor bubble which fills the complete diameter of the line. As the Taylor

<sup>1</sup>See OEPSS Databook Volume II - Ground Operations Problems.

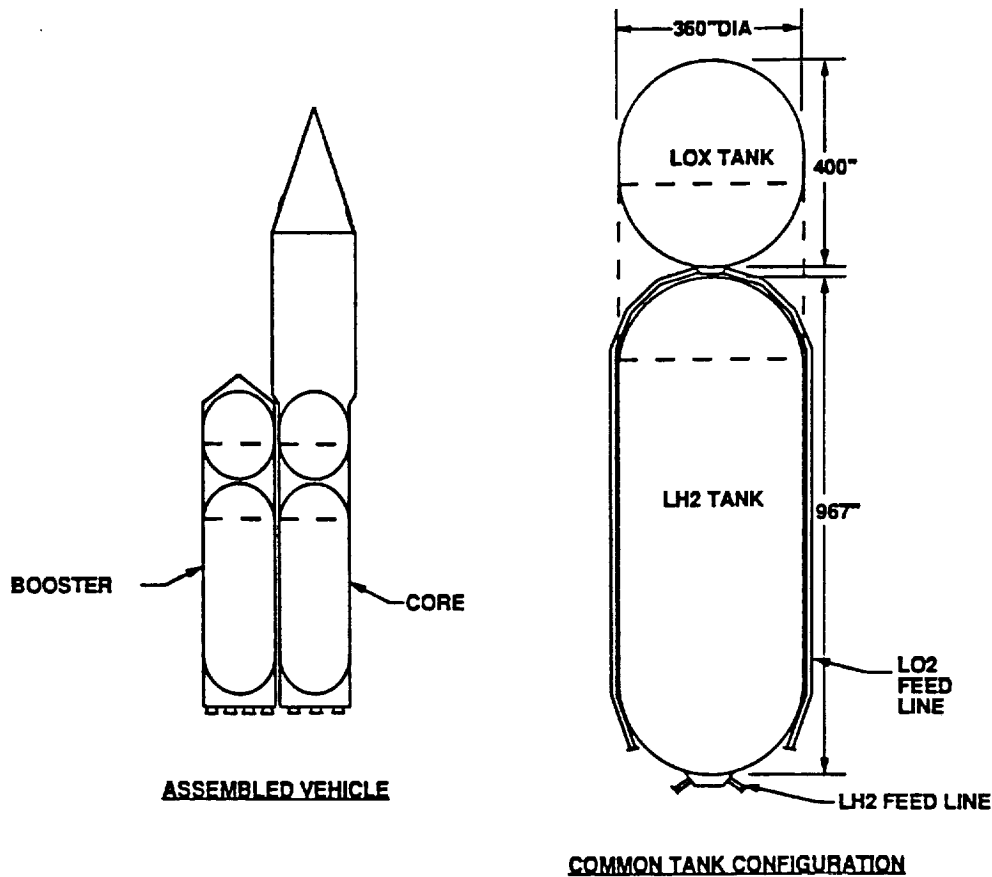

**Figure 2-1. Baseline ALS Type Vehicle**

bubble rises, it expels the liquid from the line into the tank ahead of it. When the bubble enters the tank, it rises through the liquid into the ullage. Cold liquid at the bottom of the tank then rushes into the empty line propelled not only by gravity, but by the low pressure ahead of it created by condensation of the vapor in the line. This column of liquid impacts a closed valve or other obstruction at the bottom of the line with sufficiently high velocity to create a potentially destructive water hammer surge pressure. Figure 2-2 depicts the geysering phenomenon in a cryogenic feed system.

The use of an antigeysers line can inhibit the problem. The antigeysers line (usually a smaller diameter line in parallel with the oxygen feed line), into which a low flow rate of helium is injected prior to main engine start, will provide a sustained circulation of the liquid which precludes geyser formation. For large diameter feed lines, circulation can be established without an antigeysers line if helium is injected directly into the lower part of the line. In this type of system (such as the Shuttle), termination of the helium flow will demand an immediate and proper action to prevent a potential disaster. This requires a very reliable ground and vehicle helium system, backed up by trained personnel to monitor the system operation constantly, and requires corrective action after an engine ignition abort to maintain safe control.

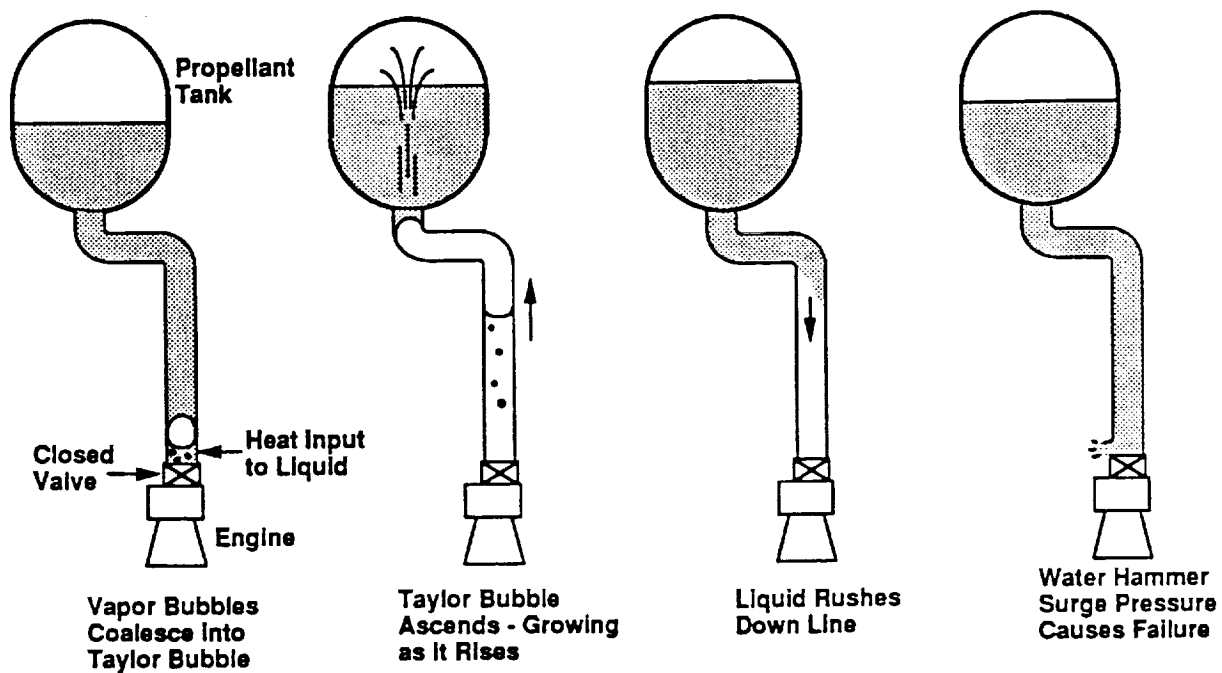

Figure 2-2. Geysering in a Cryogenic Feed System

### 2.2.2 Propellant Conditioning

The long feed lines contribute to the problem of ensuring correct propellant conditions at the engine inlet. This is especially critical prior to engine start when heating of the long lines can warm the propellant so that engine start requirements are not satisfied. Continuous bleeding off of some of the propellant at the engine inlet is a solution to this problem, but this introduces another subsystem which also requires maintenance, checkout, and servicing. In addition, the bleed is terminated prior to engine start, which limits countdown hold time after the bleed flow is discontinued.

### 2.2.3 Checkout

Another operations problem results from the long oxygen feed lines (100 to 200 ft). These lines, with their interface flanges and insulation, must be maintained and checked out. The difficulty in performing these operations is increased because of large size of the lines ( $\approx 12$  to 24 in. dia) and the fact that they are located in areas difficult to access.

### 2.2.4 Pogo

The oxygen tank forward vehicle configuration, because of the long oxygen feed lines, is susceptible to pogo. Pogo is the dynamic coupling of the structure, propellant feed system, and engine thrust. Without suppression, destructive pressure and/or thrust oscillations can occur. Any system needed to suppress pogo adds to the ground operations responsibility by adding components which must be maintained, checked out, and serviced.

### 2.2.5 Facilities

Because of the elevated position of the forward LOX tank, much higher ground transfer pressures are required for oxygen loading. This increases leakage potential and requires the use of pumps, rather than a simple pressurized transfer system. These large liquid oxygen pumps can add significantly to ground operations and can be a source of failed launch attempts. Access to critical components which are located high above the aft portion of the vehicle requires special servicing platforms. Fixed service towers would be required at the pad.

## 2.3 ALTERNATE PROPELLANT TANK CONFIGURATIONS

A preliminary evaluation was made of alternate propellant tank configurations which have the potential for reducing the operational concerns. In each case the propellant capacity is assumed to be identical to that of the baseline ALS configuration. A discussion of the advantages and disadvantages, including a summary assessment, of these options follows. Tank configurations illustrated represent one tank set of either the booster or the core stage. The same vehicle arrangement of a single booster attached to a core stage is also assumed.

### 2.3.1 LOX Tank Aft

As shown in Figure 2-3, this configuration is essentially the same as the baseline ALS except that the positions of the two propellant tanks are reversed. Feed lines again must be routed from the forward tank, but because of the smaller LOX tank, the LOX feed lines are shorter than in the baseline.

(a) **Geysering.** The short LOX feed lines preclude geysering of the oxygen, but there is potential for a hydrogen geyser. However, because of hydrogen's very low density, any water hammer surge pressure will be too low to be of concern. The spraying of liquid into the hydrogen tank ullage could cause ullage pressure collapse unless a baffle near the tank outlet is provided. The need for critical ground support equipment and highly trained personnel to monitor system operations should be eliminated.

(b) **Propellant Conditioning.** The heat transfer to the hydrogen feed system is probably somewhat greater than the baseline and may therefore add to the propellant conditioning concern. However, the short LOX lines should reduce heat input to that system.

(c) **Checkout.** The total combined feed line length is less, thus reducing checkout. Insulation of the hydrogen feed system could require more maintenance.

(d) **Pogo.** The pogo potential is reduced due to the short LOX feed lines.

(e) **Facilities.** The much lower elevation of the LOX tank reduces the pressure needed to transfer oxygen from the facility storage tank to the vehicle. This could permit using a simpler pressure transfer system rather than the much more complex and troublesome pump transfer system.



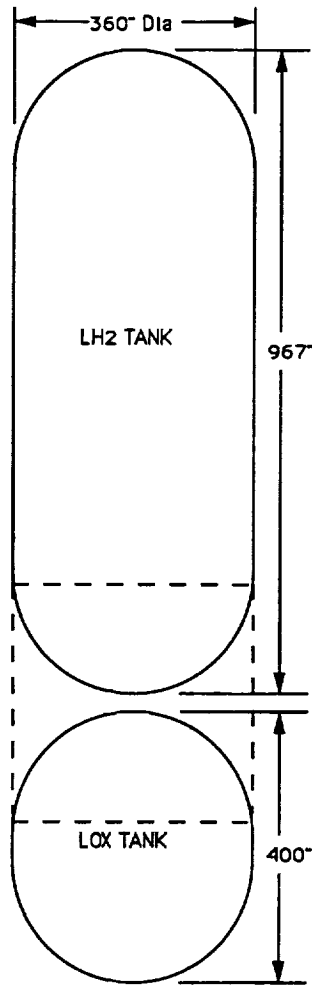

**Figure 2-3. LOX Tank Aft**

(f) **Weight.** Relative weights for the tankage only should be similar to that for the ALS baseline. The total feed line length and therefore weight for the system should be less. Since the intertank structure does not have to support the weight of the heavy oxygen tank, it can be significantly lighter.

(g) **Controllability.** This configuration provides a vehicle center of gravity which is located further aft than the baseline. The resulting shorter moment arm for a gimbaling engine provides less control moment for a given change in engine thrust vector.

(h) **Other Considerations.** Vehicle cost should be less because of the shorter propellant feed system and the lighter intertank structure.

(i) **Experience With This Configuration.** This configuration has flown on Jupiter, Centaur, Saturn S-IV, Saturn S-IVB, and Saturn S-II vehicles. However, only Jupiter was a first stage vehicle.

### 2.3.2 Parallel Long tanks

Several propellant tankage configurations are possible using arrangements of long tanks. Some are shown in Figures 2-4 through 2-7. In each of these, no long feed lines are needed for either propellant and no intertank structure is needed.

(a) **Geysering.** Because no long feed lines are used, concern for geysering with either propellant should be nearly eliminated.

(b) **Propellant Conditioning.** Positioning of engine inlets near the propellant tank outlets greatly enhances the ability to provide propellant of proper conditions to the engines. The design also could permit engine pumps to be submerged at the bottom of the tanks.

(c) **Checkout.** Feed line checkout is minimal. Tank venting systems could be more complex than the baseline, therefore requiring added checkout.

(d) **Pogo.** Because no long feed lines are used, pogo concerns should be greatly reduced.

(e) **Facilities.** Liquid oxygen must be raised to a high elevation, probably requiring pumps. No mid-tank access is necessary. Filling of multiple tanks might be complex.

(f) **Weight.** Relative weights for the tankage are estimated to be slightly higher than the ALS baseline ( $\approx 10\%$ ). Although the tank dry weight is higher, the tanks could be jettisoned in flight when depleted. The feed system weight should be low. No intertank structure is used.

(g) **Controllability.** The vehicle center of gravity is not only lower than that of the baseline, but experiences a much greater shift during engine burn. This complicates vehicle control and probably requires more engine gimbaling.

(h) **Other Considerations.** Advantage can be taken of the lower unit cost of producing many common tanks. The smaller diameter of the individual tanks will be easier to produce. Feed system cost should be low and the cost of the intertank structure is avoided.

(i) **Experience With This Configuration.** Saturn IB had a similar configuration.

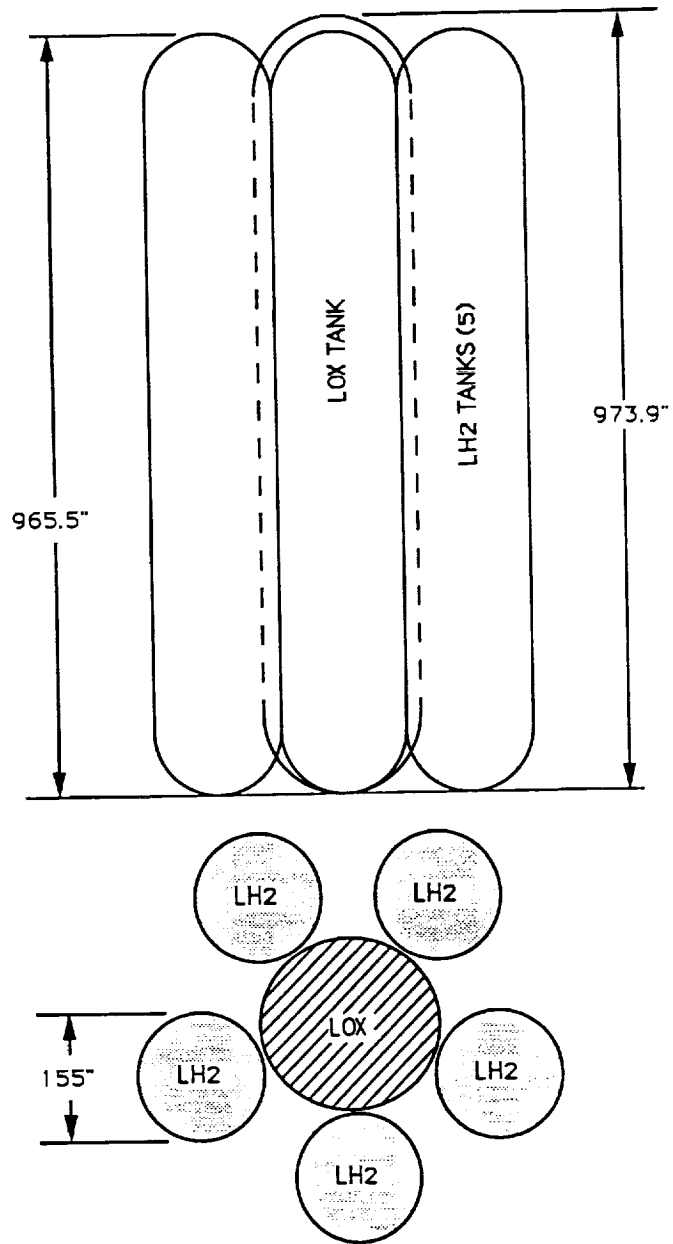

**Figure 2-4. Parallel Long Tanks – Five LH<sub>2</sub> Tanks**

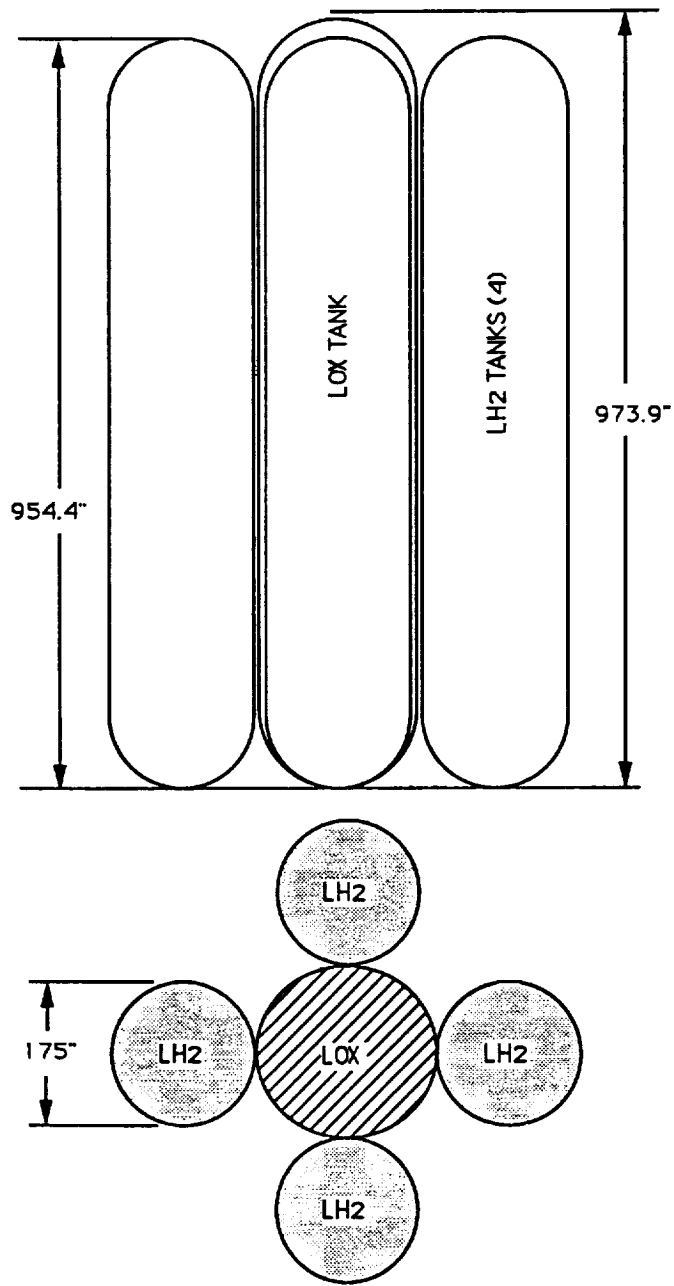

**Figure 2-5. Parallel Long Tanks – Four LH<sub>2</sub> Tanks**

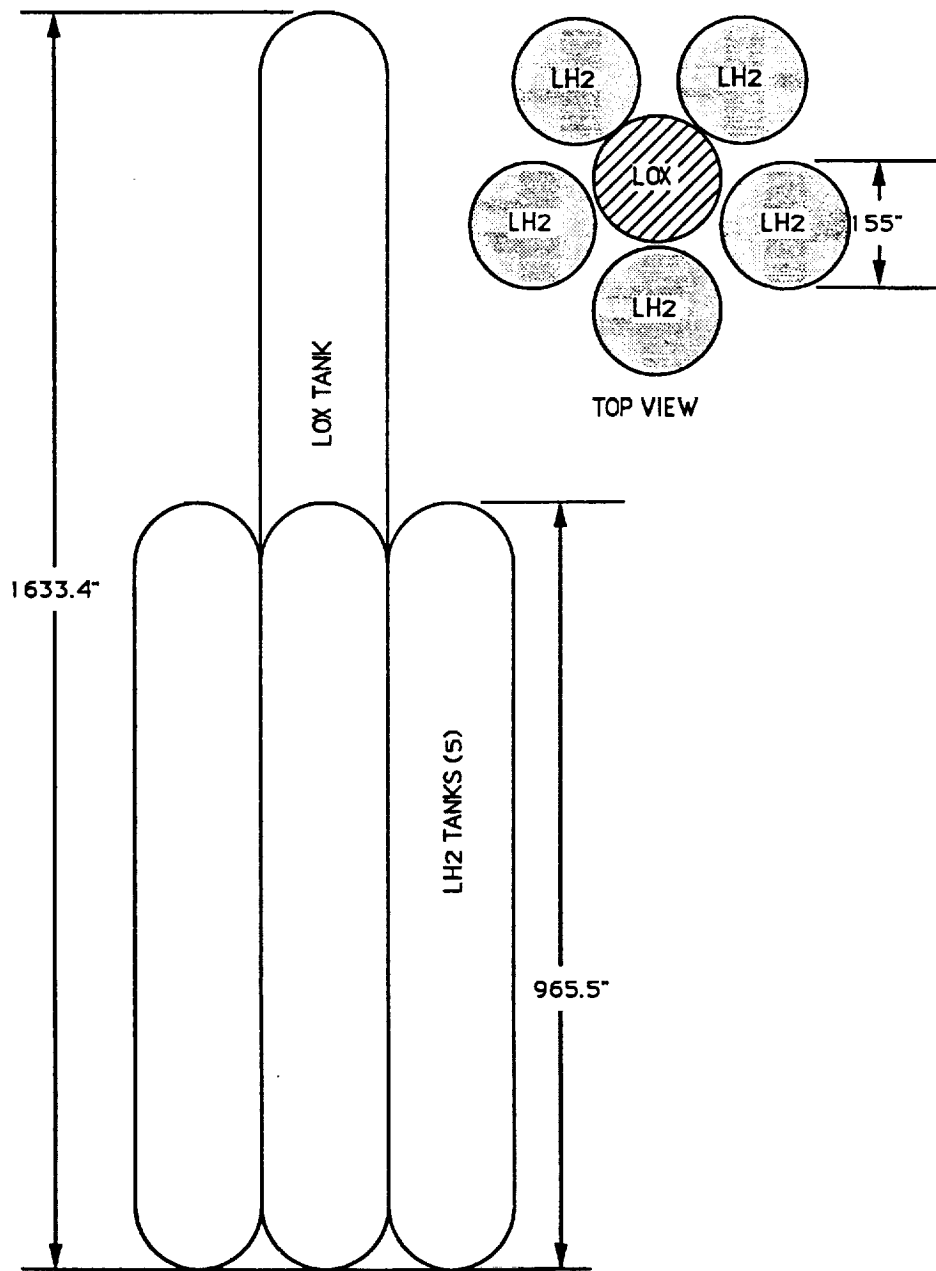

**Figure 2-6. Parallel Long Tanks—Extended LOX Tank**

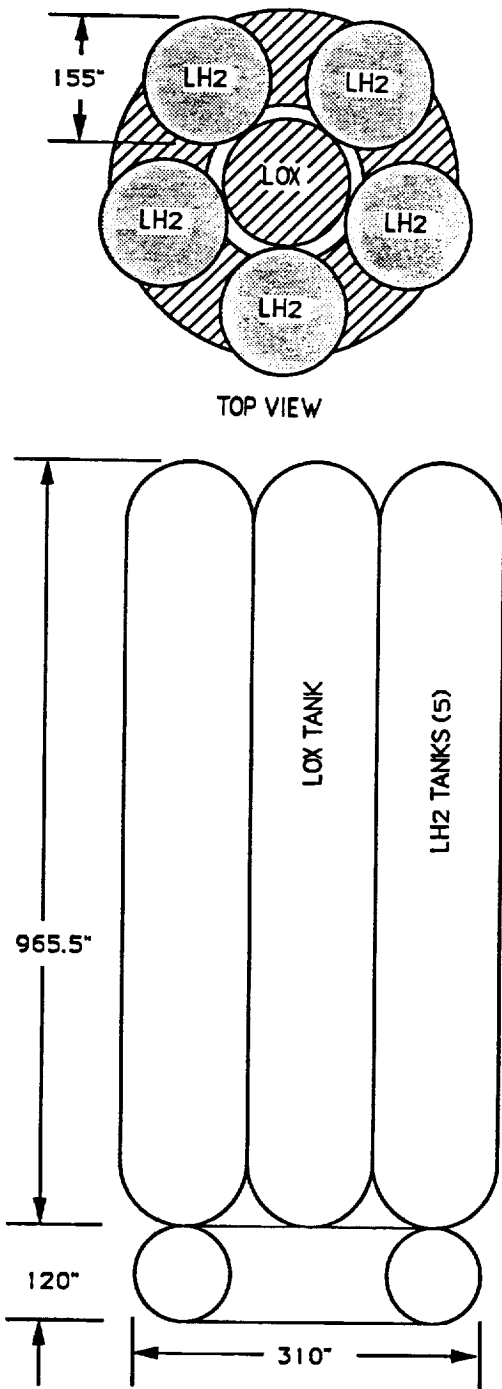

**Figure 2-7. Parallel Long Tanks – Five LH<sub>2</sub> Tanks, Two LOX Tanks**

### 2.3.3 Concentric Tanks

These configurations have the LOX tank outboard of the LH<sub>2</sub> tanks as shown in Figure 2-8 or the reverse, with the LH<sub>2</sub> tank on the outside as shown in Figure 2-9. The feed lines are short and no intertank structure is needed. The design must account for differential thermal contractions of the tanks.

(a) **Geysering.** Because no long feed lines are used, concern for geysering with either propellant should be nearly eliminated.

(b) **Propellant Conditioning.** Also, positioning of engine inlets near the propellant tank outlets greatly enhances the ability to provide propellant of proper conditions to the engines. The design could permit engine pumps to be submerged at the bottom of the tanks.

(c) **Checkout.** Only one tank for each propellant and short feed system should simplify checkout.

(d) **Pogo.** Pogo should not be a problem with this configuration.

(e) **Facilities.** Liquid oxygen must be raised to a high elevation, probably requiring pumps. No mid-tank access is necessary.

(f) **Weight.** Relative weights for the tankage are estimated to be nearly twice the ALS baseline. The feed system weight is low and no intertank structure is used.

(g) **Controllability.** From the controllability standpoint, this configuration is very similar to the parallel long tank configurations. The low vehicle center of gravity which has a large shift during engine burn complicates vehicle control and probably requires more engine gimbaling.

(h) **Other Considerations.** A short feed system and no intertank structure will lower costs. However, determining cost of the basic tankage requires a manufacturing analysis and will depend on the innovative techniques used to fabricate the unusual tank configurations.

(i) **Experience With This Configuration.** No vehicles of this configuration are known to have been developed.

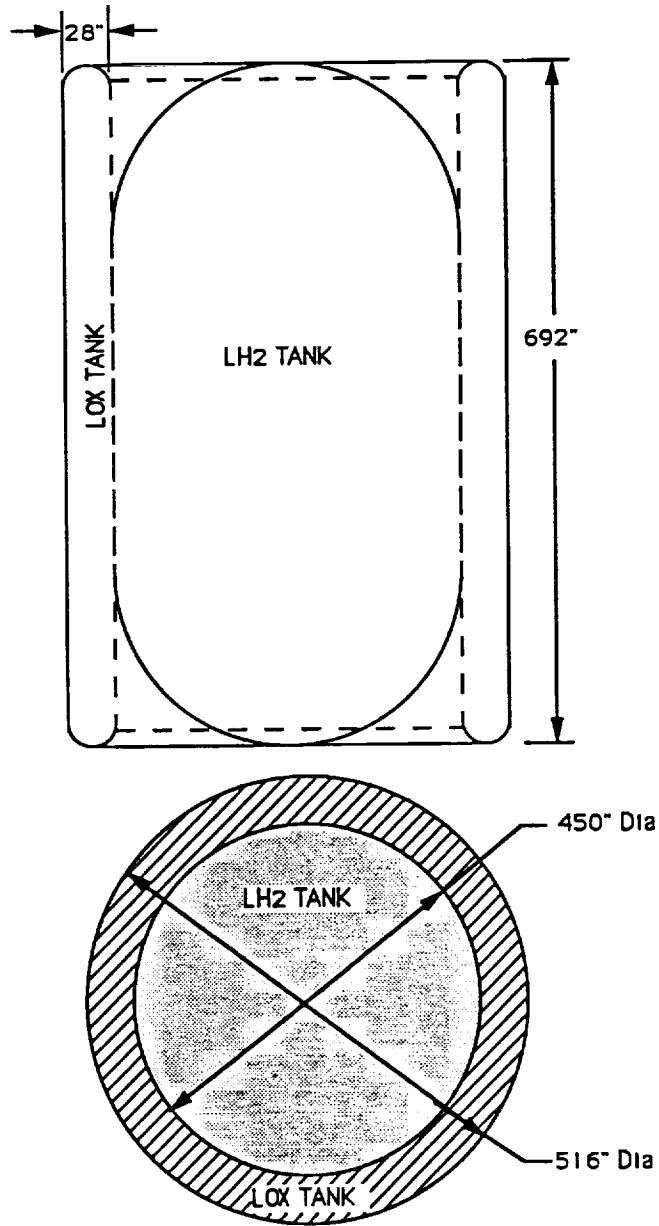

Figure 2-8. Concentric Tanks—LOX Tank Outboard



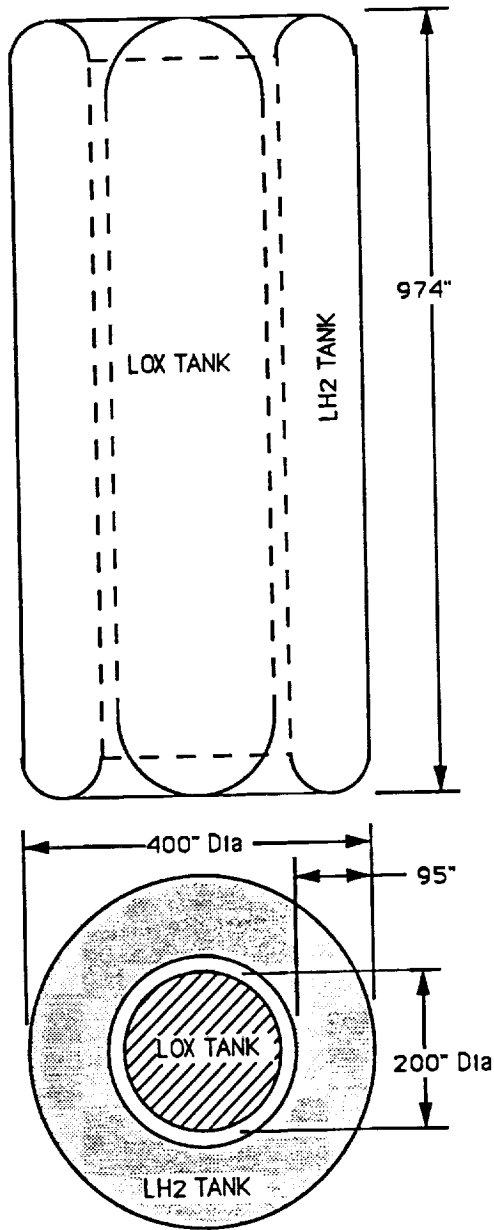

Figure 2-9. Concentric Tanks—LOX Tank Inboard

### 2.3.4 Toroidal LOX Tank

This configuration, shown in Figure 2-10, has a conventional forward portion of the LH<sub>2</sub> tank with a conical aft end to fit within the toroidal LOX tank. The LOX tank is not required to carry any thrust loads. These loads are efficiently carried forward by the LH<sub>2</sub> tank.

(a) **Geysering.** Because no long feed lines are used, concern for geysering with either propellant should be nearly eliminated.

(b) **Propellant Conditioning.** Positioning of engine inlets near the propellant tank outlets greatly enhances the ability to provide propellant of proper conditions to the engines. The design could permit engine pumps to be submerged at the bottom of the tanks.

(c) **Checkout.** As with the concentric tanks, only one tank for each propellant and short feed system should simplify checkout.

(d) **Pogo.** Pogo should not be a problem with this configuration.

(e) **Facilities.** The very low elevation of the oxygen tank reduces the pressure needed to transfer oxygen from the facility storage tank to the vehicle. This could permit using a pressure transfer system rather than the much more complex and troublesome pump transfer system. Nearly all critical systems are located in the aft area, easing access requirements. No mid-tank access is necessary.

(f) **Weight.** Relative weights for the tankage are estimated to be higher than the ALS baseline ( $\approx 30\%$ ). The feed system weight is low and no intertank structure is used.

(g) **Controllability.** Controllability issues should be similar to the LOX tank aft configuration. The vehicle center of gravity is located further aft than the baseline. The resulting shorter moment arm for a gimbaling engine provides less control moment for a given change in engine thrust vector. Travel of the vehicle center of gravity during engine burn is less than the parallel long tank or concentric tank configurations.

(h) **Other Considerations.** Cost should be close to that of the baseline if low cost techniques can be developed to manufacture the toroidal oxygen tank. Intertank cost is eliminated and feed system costs are low.

(i) **Experience With This Configuration.** No large vehicles of this configuration are known to have been developed.

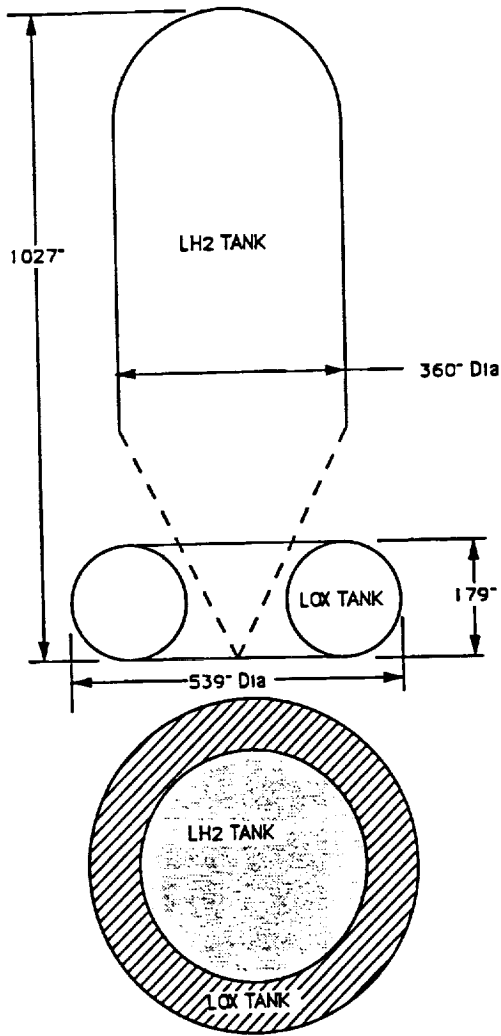

**Figure 2-10. Toroidal LOX Tank**

## 2.4 ALTERNATE TANK CONFIGURATION COMPARISON

In addition to the evaluation of operational advantages of the alternative tankage configurations, a preliminary assessment of weights and cost was made relative to the ALS baseline configuration. The relative results are presented below.

### 2.4.1 Relative Weights

In determining relative weights for the baseline and alternate tank configurations, the following basis was used for the evaluation:

- Aluminum tank structure
- Nominal tank ullage pressure = 50 psi
- System oxidizer-fuel mixture ratio = 6.0
- Liquid oxygen tank volume = 18,561 ft<sup>3</sup>  
Temperature = 164°R  
Density = 70.94 lb/ft<sup>3</sup>
- Liquid hydrogen tank volume = 49,892 ft<sup>3</sup>  
Temperature = 37°R  
Density = 4.40 lb/ft<sup>3</sup>

Figure 2-11 shows the relative weights of the tankage for the various alternate configurations considered.

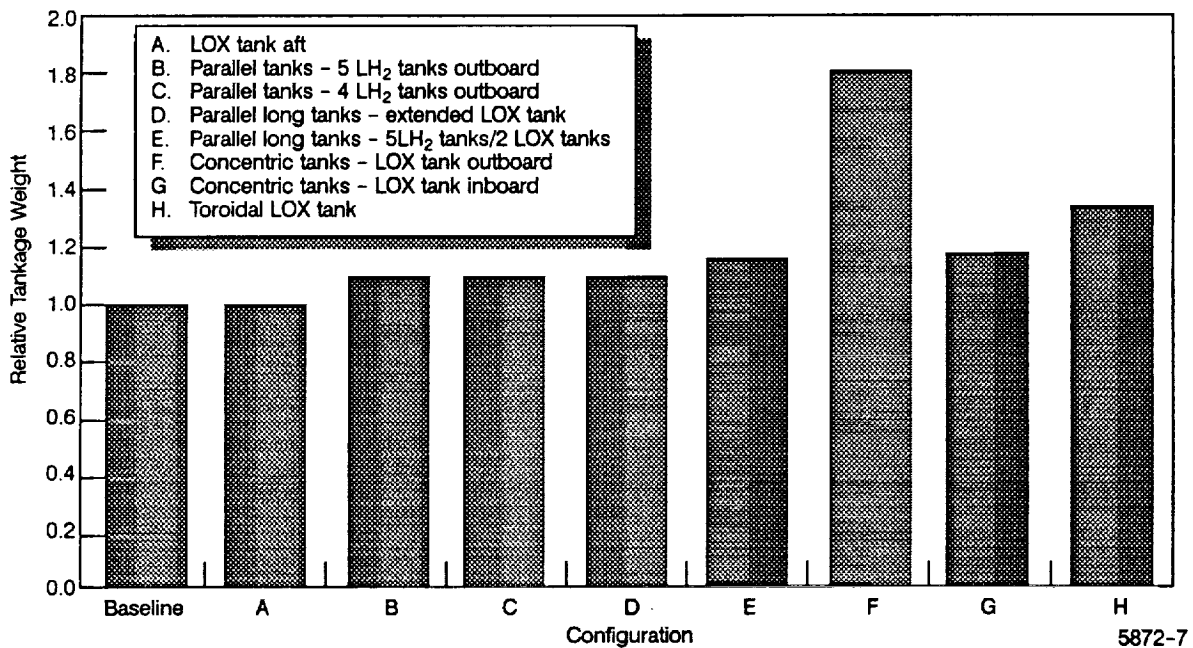

Figure 2-11. Relative Weights of Alternative Tank Configurations

In view of the potential operational advantages of avoiding major operations problems currently being faced today, and the high operations cost incurred as a result of these serious problems, the alternative LOX tank aft and parallel tank configurations certainly merit strong consideration for future launch systems, with the moderate weight increase notwithstanding.

### 2.4.2 Relative Cost

For the relative cost assessment, a production rate of 15 vehicles per year was used. Dry weight, surface area, and complexity were factors considered. These factors were assigned values from 1 (less complex, lightest, etc.) to 8 (most complex, heaviest, etc.). The results are shown in Table 2-1 with the tank configurations identified as in Figure 2-11.

In view of the significant operational advantages of greatly reducing the complex operations requirements and extensive facility support by avoiding current operations problems, the LOX-tank aft and parallel tank configurations deserve serious consideration for future launch system designs. Manufacturing techniques will undoubtedly be developed to reduce or eliminate the relative cost differential between the alternative tank configurations and the present ALS baseline configuration.

**Table 2-1. Relative Cost Ranking of Alternate Tank Configurations**

Tank Configuration	Dry Weight	Surface Area	Complexity	Total
Baseline LOX-tank forward	1	1	1	3
A. LOX-tank aft	1	1	1	3
B. Parallel	3	3	4	10
C. Parallel	2	2	3	7
D. Parallel	4	4	2	10
E. Parallel	5	5	5	15
F. Concentric	8	8	7	23
G. Concentric	6	6	6	18
H. Toroidal	7	7	8	22

D800-0011

## 2.5 VEHICLE CONTROL ASSESSMENT

Launch vehicle gimballed angle requirements for thrust vector control are determined from the maximum gimballed angle required to control and steer the vehicle during ascent. Thrust vector control is used to counter the effect of disturbance moments resulting from the following sources:

- Atmospheric aerodynamic disturbance
- Thrust misalignment
- Asymmetry of engine location
- Engine failure

Because of the concern that vehicle control may be difficult or impossible unless the liquid oxygen tank is forward, and since all the alternate tank configurations resulted in the vehicle center of gravity located further aft than the ALS baseline, and in a shorter moment arm for engine gimbaling, a control analysis of one of the alternate configuration was made. The configuration selected for analysis is the concentric tank arrangement because the large change in vehicle center of gravity presents a difficult control problem, especially with the side-mounted booster arrangement. The long parallel tank configurations also show the same center of gravity excursions and therefore the results also apply to these configurations.

The trajectory used in the analysis is one typical for ALS missions, and is represented by the parameters shown in Figure 2-12.

### **2.5.1 Aerodynamic Disturbances**

Aerodynamic disturbance forces occur only during the atmospheric flight and are proportional to the product of the dynamic pressure ( $Q$ ) and the angle of attack ( $\text{Alpha}$ ) or angle of sideslip ( $\text{Beta}$ ). For a typical launch, vehicle  $Q$  increases from zero at lift-off to a maximum value ( $Q_{\text{max}}$ ) and then decreases again to zero outside the atmosphere. As shown in Figure 2-12,  $Q$  increases from zero to a maximum of about 700 psf at about 40,000 ft altitude and then decreases to zero at about 160,000 ft.

The angle of attack  $\text{Alpha}$  (or angle of sideslip  $\text{Beta}$ ), due to wind acting normal to the vehicle axis, continues to decrease as the vehicle velocity increases. The product of the dynamic pressure and the angle of attack ( $Q \cdot \text{Alpha}$ ) or angle of sideslip ( $Q \cdot \text{Beta}$ ) has a maximum value, not necessarily at  $Q_{\text{max}}$ , which corresponds to the maximum aerodynamic force acting on the vehicle.

As a result of the change in the position of the vehicle center of gravity ( $\text{CG}$ ) due to propellant consumption (shown in Figure 2-13) and the change in the location of the center of pressure ( $\text{CP}$ ) due to the increase in Mach number, the aerodynamic moment arm about the  $\text{CG}$  also continues to change with a maximum value occurring at Mach 1.

### **2.5.2 Thrust Misalignment**

The total thrust misalignment with respect to the launch vehicle axis results from the individual engine thrust misalignment and from vehicle structural flexibility. For worst case analysis, all engines are considered to be misaligned in the same direction. A constant misalignment value of 0.75 deg can be applied to all engines.

### **2.5.3 Asymmetric Engine Locations**

Due to the difference in the number of engines between the booster and the core vehicle, a large pitching moment acts on the vehicle from lift-off until booster separation. Also, because of the weight of the payload and the shroud, the moment arm of the booster engines about the  $\text{CG}$  is larger than that of the core vehicle. In addition, the ratio of the booster engines arm to the core vehicle moment arm continues to increase in flight resulting in an increase in the pitching (down) moment. As shown in Figure 2-13, the maximum moment occurs at the booster engines shutoff.

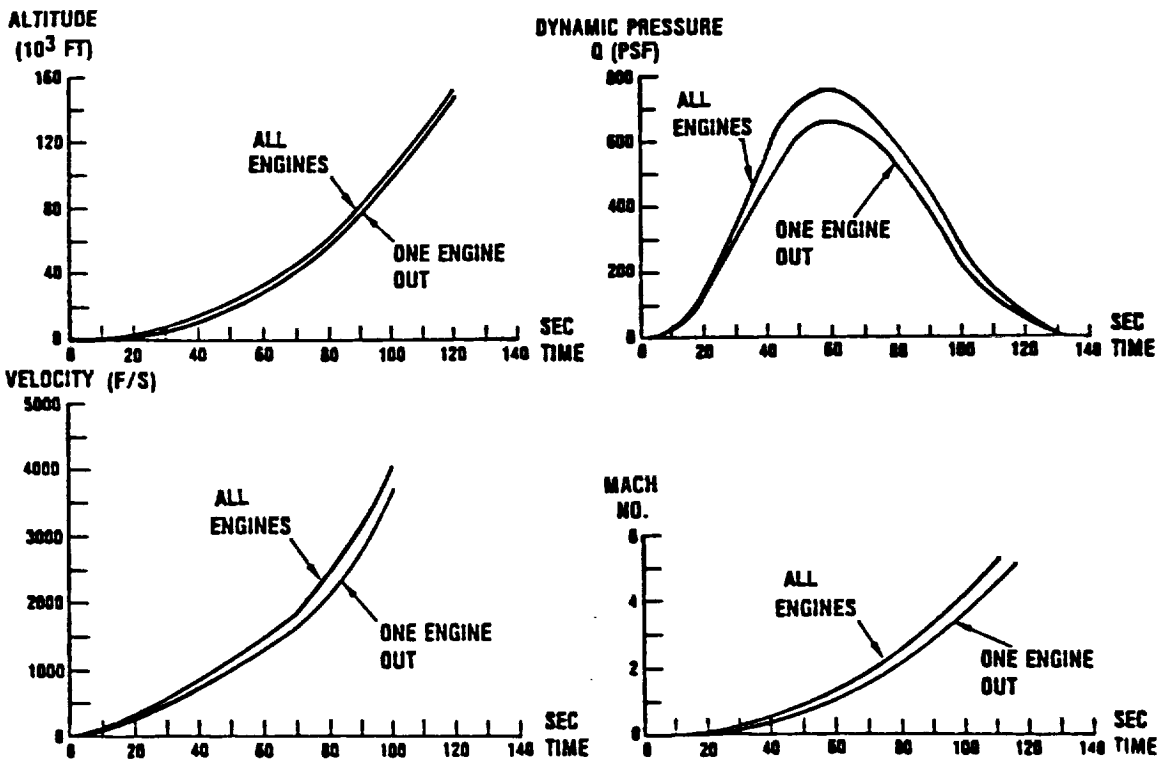
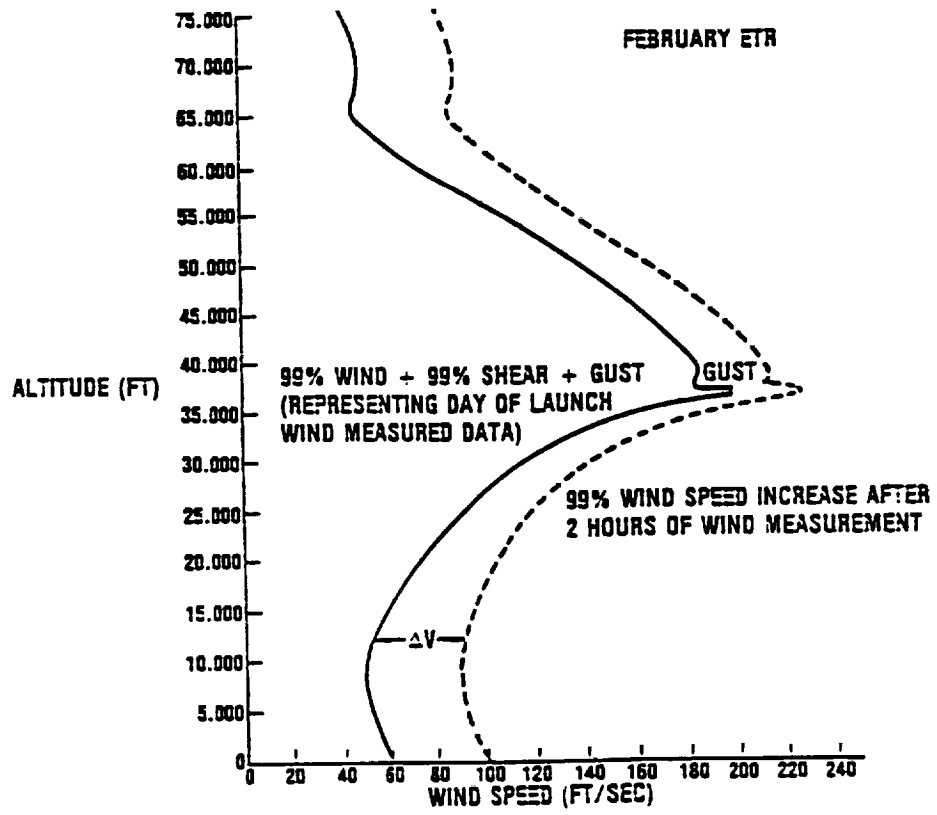

Figure 2-12. Parameters for Typical ALS Trajectory

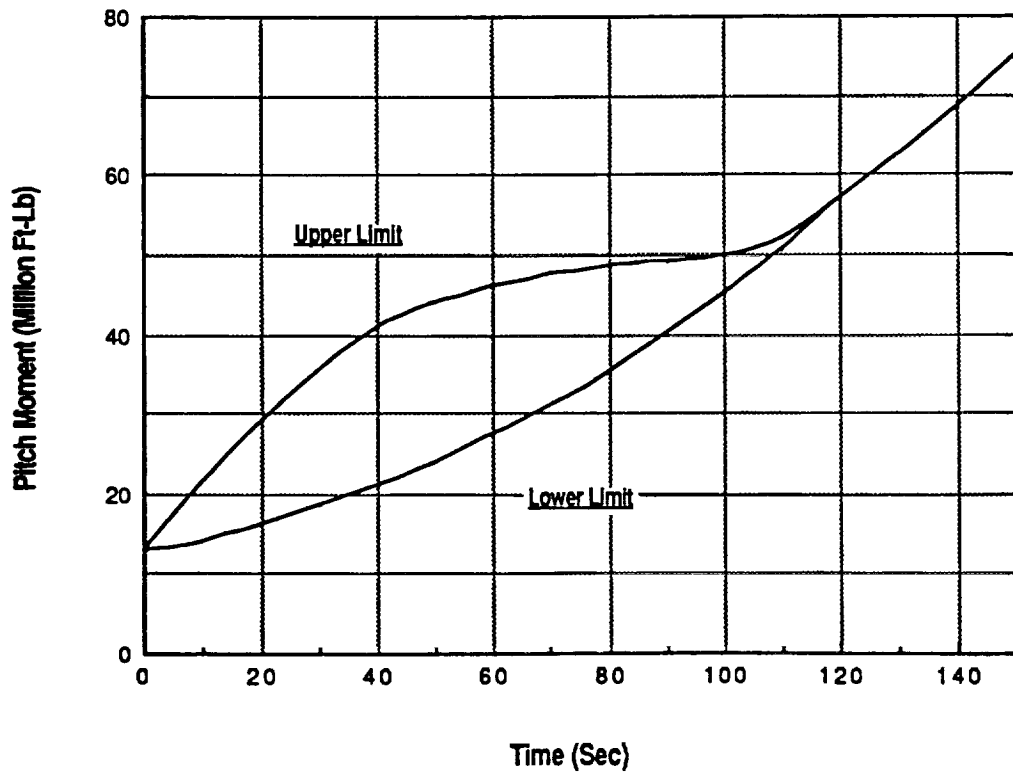
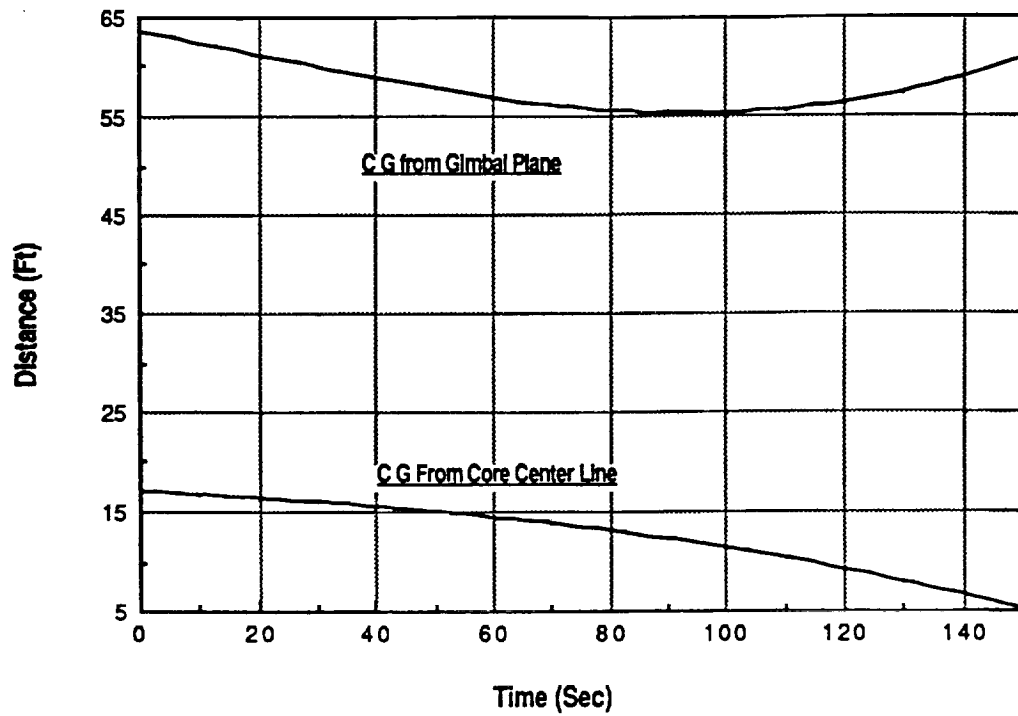

Figure 2-13. Center of Gravity and Pitching Moment Changes



#### 2.5.4 Engine Failure

A failure in one of the engines at lift-off results in an unbalance pitch and/or yaw moment throughout the flight. A failure in a booster engine could actually decrease the pitch down moment, while a failure in a core engine will increase it. Therefore, a core engine failure (particularly the one furthest from the booster) constitutes a worst-case condition. In this case the moment's unbalance continues even after booster separation. As a result of the failure of a core engine, the booster engine's moment arm increases during flight due to the lower propellant consumption in the core vehicle. This results in an increase in the pitch (down) moment.

#### 2.5.5 Results

Gimbal angle requirements for ALS (engine out case) are shown in Figure 2-14(a) as a function of ascent time. The gimbal angle requirements include the angles required to compensate for the disturbance moments and an additional 2 deg to control and steer the vehicle. Assuming that all engines (both the core vehicle and booster) are gimballed, the required gimbal angles increase from 12.5 deg at lift-off to 24 deg at booster shutoff. At the point of maximum aerodynamic moment, the required gimbal angle reaches 21 deg. However, if the booster engines are canted by 10 deg toward the core vehicle, the maximum gimbal angle requirement decreases to 16 deg at booster engines shutoff. After booster separation, the remaining two core vehicle engines require 8 deg gimbal angle (6 deg to offset the failed engine and 2 deg for vehicle control).

Thrust loss resulting from gimbaling all engines to compensate for engine asymmetry and booster engine canting are shown in Figure 2-14(b). The maximum thrust loss value reaches 6% at booster shutoff. Booster engines canting effect seems to be very small and diminishes toward booster separation.

The results indicate that although the controllability of the alternate tank configurations do require higher gimbal angles, they are not beyond the capability of a good integrated propulsion system design. Changing from a side-mounted booster to a more symmetrical vehicle configuration would greatly simplify the control problem and quite possibly eliminate the requirement for booster engine gimbaling. Certainly, the control requirements for the alternate tank configurations should not preclude their consideration in future launch system designs in view of their potentially large gains in reducing ground operations requirements and associated large reduction in operations cost.

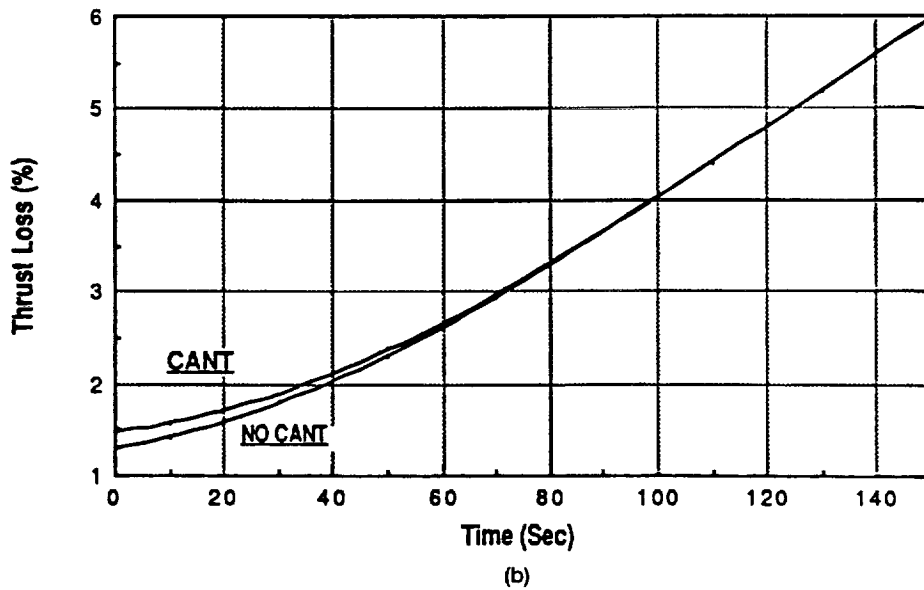
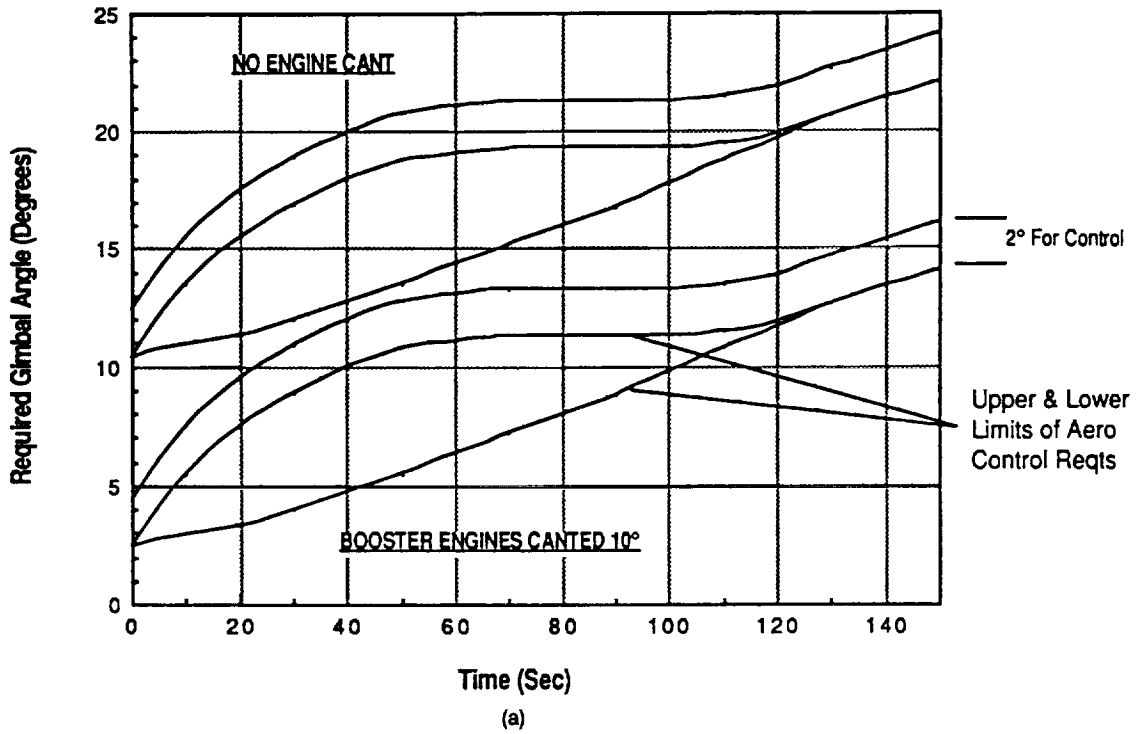

Figure 2-14. Engine Gimbal Requirements and Thrust Loss from Canting

### 3.0 AIR-AUGMENTED, ROCKET ENGINE NOZZLE AFTERBURNING PROPULSION CONCEPT

Many combined-cycle studies have been conducted in the past where rocket and air-breathing modes of operation are combined in a single propulsion system (Refs. 1, 2, and 3). The primary focus of these studies is to achieve high specific impulse and thrust-to-weight ratio of the propulsion system obtained by utilizing the atmospheric oxygen in the air through which the system flies. The amount of oxygen (or oxidizer) carried by the rocket vehicle to fly through the atmosphere is as much as 40 to 50% of the vehicle gross liftoff weight (GLOW). The reason why the OEPSS study is investigating air-augmented propulsion is not performance (achieved by more sophisticated, complex combined-cycle engines), but the potential for (1) eliminating our complex operational requirements, (2) reducing our escalating operations cost, and (3) increasing the operational efficiency of our launch vehicles to achieve routine space flight.

The focus of the OEPSS air-augmented study, therefore, is to investigate the feasibility of using a simple, fixed-geometry, passive ejector system to achieve thrust augmentation with a LOX/LH<sub>2</sub> rocket engine afterburning with air, even for over a limited flight regime from liftoff. The SSME exhaust plume study (Figure 3-1) indicated that as much as 2,000 lb of air is entrained and approximately 50% of the exhaust excess hydrogen (fuel rich) is burned by mixing and combustion of supersonic nozzle exhaust gas with ambient air in about 5 diameters (40 ft) downstream of the SSME nozzle.

Previous experimental studies by Martin Marietta Corp. showed that as much as 14% thrust augmentation at liftoff with a hydrogen peroxide engine (Ref. 1) and 55% at Mach 2.0 with a LOX/RP-1 engine (Ref. 2) were obtained by using a simple divergent ejector shroud designed for low secondary to primary mass flow ratio and supersonic mixing and combustion. The operational implication of thrust augmentation, i.e., eliminating the large amount of liquid oxygen that must be carried by a LOX/LH<sub>2</sub> vehicle, is most significant. The reduction in liquid oxygen handling, or a smaller vehicle, will greatly simplify ground operations and reduce ground support equipment. Indeed, if thrust augmentation can reduce a multistage to a single stage vehicle, the doubling and tripling ground operations required for multiple boosters and core would be avoided.

Thus, the purpose of the present study is to explore the viability of an air-augmented ejector/rocket concept for a LOX/LH<sub>2</sub> rocket engine in light of previous work and in view of more current state of art. This concept merits study especially because there is a great need to increase the operational efficiency of future launch vehicles to decrease operations cost.

---

<sup>1</sup> A. J. Simonson and J. W. Schmeer, "Static Thrust Augmentation of a Rocket-Ejector System with a Heated Supersonic Primary Jet," NASA TND-1261, Langley Research Center, May 1962

<sup>2</sup> E. A. Mossman, R. L. Chapman, and R. C. Rozycki, "Experimental and Theoretical Investigation of the Rocket Engine Nozzle Ejector (RENE) Propulsion System," AFRPL, TR-65-66, April 1965

<sup>3</sup> R. W. Foster, W. J. D. Escher, and J. Robinson, "Air Augmented Rocket Propulsion Concepts," AFAL, TR-88-004, January 1988

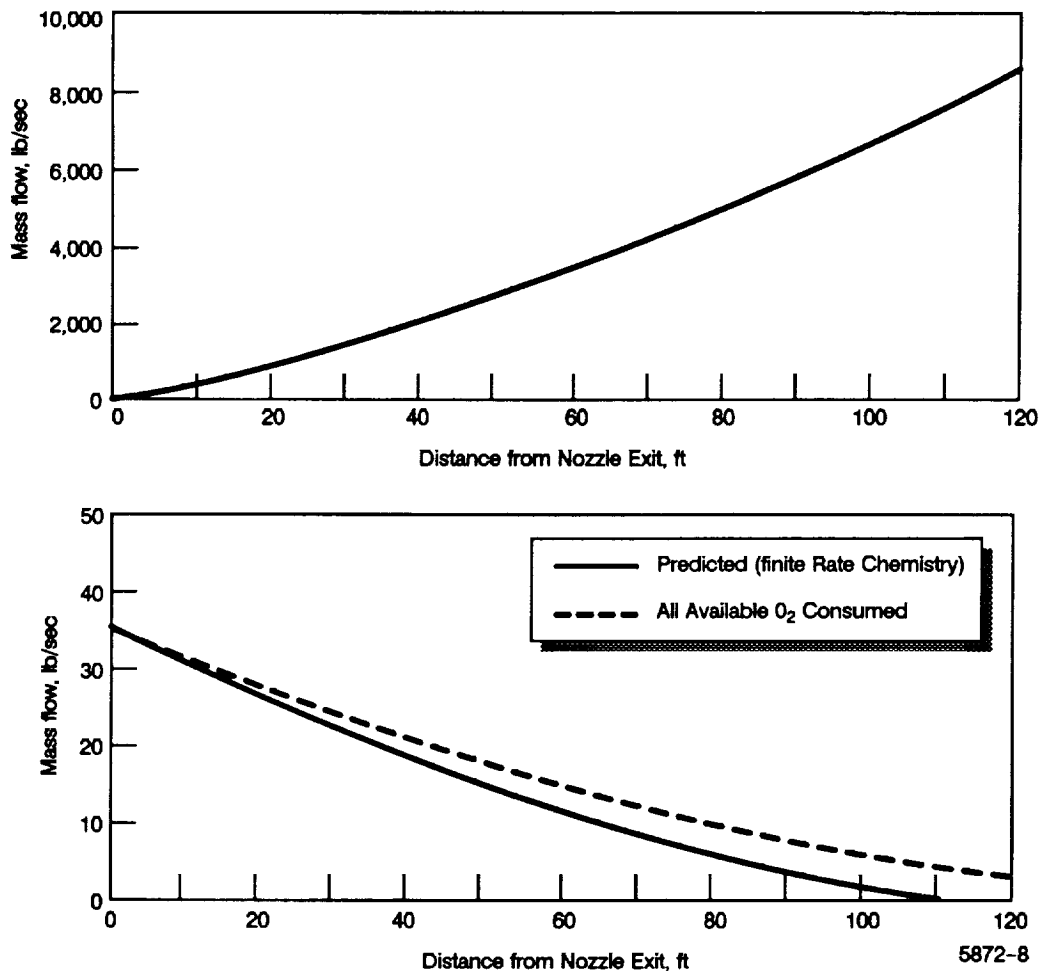

Figure 3-1. SSME Plume Study

### 3.1 THRUST AUGMENTATION

The simplest form of air-augmentation of a rocket propulsion system is to install a simple geometry, lightweight extension to the rocket engine nozzle. The air-augmented, rocket concept, therefore, is simply a conventional rocket engine (like the STME) shrouded by a simple ejector which captures, directs, and mixes atmospheric air with the rocket nozzle exhaust gas. Air-augmented thrust is obtained by the ingestion, compression, mixing, and combustion of air with the exhaust gas. This concept is promising since all rocket propulsion systems have excess fuel in their exhaust gas, and if (the otherwise wasted chemical energy of) this fuel contained in the mixture of fuel-rich exhaust is combusted with the ingested atmospheric air and further expanded in a divergent section, additional thrust (and increased  $I_{sp}$ ) is produced from additional expansion of the combustion gases.

Figure 3-2 illustrates the simple ejector/rocket propulsion system concept. A conventional bell nozzle of a rocket engine is surrounded by an ejector consisting of the air inlet and a divergent mixing/afterburning chamber. The two streams, primary stream formed by rocket exhaust and secondary stream consisting of atmospheric air, begin to mix at the exit of the rocket engine nozzle. In the mix-

ing process, part of the primary stream's high kinetic and thermal energy is transferred to the secondary stream by direct momentum exchange. Additional thermo/chemical energy is released by combustion of fuel-rich exhaust gases. In the process of energy exchange, the momentum flux of the fluid increases and produces useful thrust.

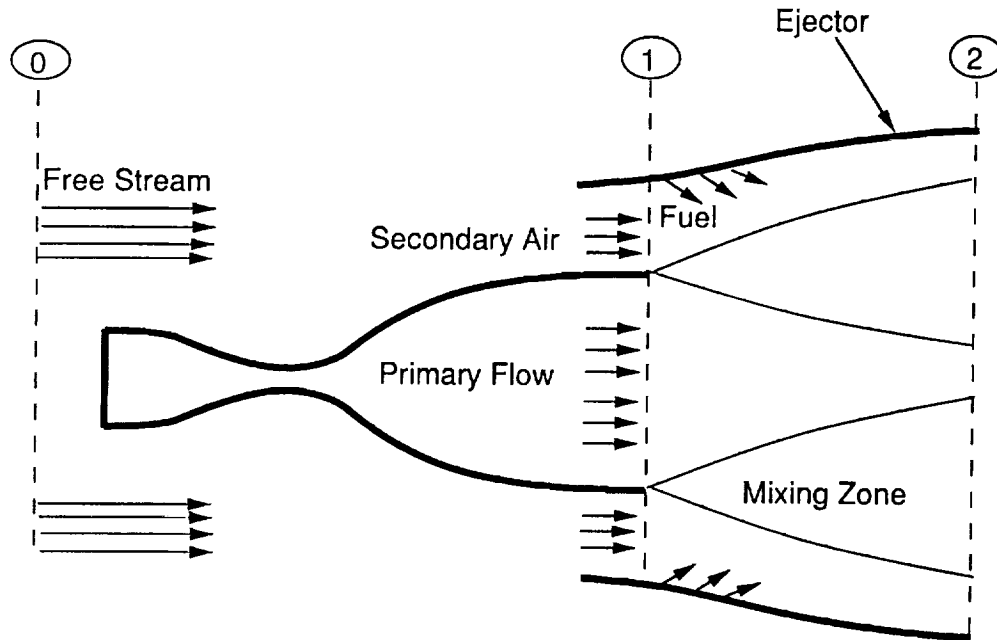

Figure 3-2. Rocket Engine Air-Augmented Afterburning Concept

### 3.1.1 Assumptions

Ejector performance (thrust) is affected by ambient air (free-stream) condition, flight velocity, secondary flow condition (inlet geometry and pumping capability), primary rocket flow thermo-chemical condition, energy released by combustion of ingested air with nozzle exhaust excess fuel, and ejector geometry. Most importantly, ejector performance depends on the level of mixing between primary and secondary flows and the combustion of secondary air with the rocket exhaust excess fuel. The pumping capability of an ejector depends on the level of mixing between the two streams and, therefore, mixing and pumping are interrelated and, especially at low speeds, any change in the mixing directly affects pumping and vice versa.

Certain initial assumptions were made in the present study to simplify calculations. A simplified approach was taken to eliminate tedious and time consuming, sophisticated/advanced calculation techniques, yet perform first level analysis that will assess the viability of an ejector/rocket propulsion system. One dimensional inviscid, ideal flow with equilibrium chemistry and jumped (path independent) calculation was conducted. All effects of flow multi-dimensionality, nonuniformities (pressure, temperature, velocity, Mach number, and chemical composition), viscosity, incomplete mixing and pumping, and chemical kinetics were neglected. Detail losses associated with shocks due

to flow interactions, velocity vector (divergent), incomplete mixing and combustion, wall heat transfer and internal drag were not considered, and it is assumed that mixing and combustion is complete (equilibrium) at the ejector exit. For simplicity, the effect of boundary layer (developed on the air induction system wall and on the primary nozzle wall) on ejector mixing/pumping, base flows, and nozzle lip effects also were neglected. Similarly, possible flow separation in the primary nozzle and ejector section due to any adverse pressure gradient and shock boundary layer interaction were neglected, and the system was assumed to be flowing full.

### 3.1.2 Thrust Calculation

In order to determine ideal thrust generated by the ejector/rocket, the ambient primary and secondary flow conditions at the plane where mixing starts (station 1, Figure 3-2), and the ejector geometry must be known. Primary flow condition at the rocket engine nozzle exit was determined based on the following STME GG cycle engine main combustion chamber data: thrust chamber pressure ( $P_c$ ) of 2,250 psia, mixture ratio (MR) of 6, fuel ( $H_2$ ) temperature of  $190^\circ R$ , and LOX temperature of  $170^\circ R$ , and the flow was expanded with equilibrium chemistry to a nozzle area ratio of 40 to determine rocket engine nozzle exit flow conditions (Ref. 4). The secondary air flow conditions were determined based on free-stream static pressure, temperature and flight velocity, and in the subsonic flight regime the secondary inlet flow was assumed choked ( $M_s = 0.9$ ), and at supersonic flight speeds ( $M_o = 2$ ) it is shocked down to subsonic flow. The isentropic inlet process determines secondary flow conditions at subsonic flight speeds, but in order to account for inlet total pressure loss (entropy rise) at flight Mach number of 2 the free-stream total pressure was adjusted according to inlet kinetic energy efficiency reported by Marquardt on ejector/ramjet test (Ref. 5).

Mathematically, the ejector is described by applying the conservation laws, along with the equation of state for ideal gases, between the two stations 1 and 2 (beginning mixing and ejector exit) as shown in Figure 3-2. One dimensional equilibrium ejector code developed by Dr. L. Burkardt at NASA LeRC (Ref. 6) was modified and used to facilitate ejector thrust calculations. Ejector wall pressure force is determined by linear pressure distribution along the flow axis, assuming the inlet wall pressure is due mostly to the secondary stream. The calculated ejector/rocket thrust includes air inlet ram drag and total pressure losses and therefore represents the net thrust or thrust augmentation obtained.

## 3.2 DESIGN ISSUES

Some of the key issues that must be addressed in the design, performance, and application of the air-augmented ejector/rocket system during the study are discussed below.

---

<sup>4</sup> S. Gordon and B. J. McBride, "Computer Program for Calculation of Complex Chemical Equilibrium Compositions, Rocket Performance, Incident and Reflected Shocks, and Chapman-Jouguet Detonations," NASA SP-273, March 1976

<sup>5</sup> E. A. Odegaard and K. E. Stroup, "Advanced Ramjet Concepts," The Marquardt Corporation Technical Report AFAPL-TR-67-118 Volume VIII, January 1968

<sup>6</sup> L. Burkardt, Preliminary report of Ejector Computer Program, developed at NASA Lewis Research Center

### **3.2.1 Operating Flight Regime**

The design complexity of an air-augmented ejector/rocket system is primarily dependent on the range of flight Mach number over which thrust augmentation is desired. If rocket thrust augmentation is desired over a wide range of operation, a variable geometry shroud would be required and net vehicle thrust increase must be traded off against design complexity and system weight.

For a smaller range of operation, a simple fixed-geometry ejector can be used up to flight Mach number of about 2 to 3 after which the shroud may be jettisoned or, if nozzle pressure ratio is high enough and the level of design complexity is acceptable, it can remain attached to the nozzle and be used as a rocket engine nozzle extension for high altitude performance. It will be advantageous to use a lower area ratio rocket nozzle (lower weight) if this option is exercised, since the rocket nozzle exhaust flow is usually overexpanded at low flight speeds.

For a wider range of operation from take-off to a flight Mach number of about 6 (ejector/rocket to ram/rocket to all rocket), a variable geometry shroud would obviously be required for efficient air induction and mixing (exchange of momentum). Again, at flight speeds over Mach 6, for all-rocket operation, the shroud could be jettisoned or remain attached and be used as a rocket nozzle extension to increase nozzle performance (higher area ratio) during high altitude flight.

If the ejector concept is applied to existing rocket propulsion systems, the shroud design could be tailored to enhance rocket performance with minimal changes to the existing system hardware. However, if the concept is being considered for a new engine, the combined propulsion system and the vehicle must be designed and integrated to provide optimum operation for the mission.

### **3.2.2 Air Induction System**

For a simple ejector/rocket at low Mach numbers, the performance of the secondary air inlet system is not as critical as it is for supersonic speeds where the ingested air is decelerated to subsonic speed by means of shocks and high total pressure recovery with minimum drag is essential. While these objectives are certainly emphasized in any air breathing propulsion systems, the overall performance of an air-augmented rocket is not quite as sensitive to these parameters as the performance of a pure air breather such as a ramjet.

At low speeds, the pumping capability of the ejector/rocket system mainly depends on air inlet geometry, ambient inlet air and nozzle exhaust flow conditions, and shroud geometry. Since most rocket engine nozzle exhaust flow is overexpanded at low speed, primary/secondary flow interaction is complicated by embedded shocks and Mach disks. For the ALS type trajectory, the nozzle exhaust flow is overexpanded up to about 26,000 ft.

### **3.2.3 Mixing/Combustion**

The key to achieving high ejector/rocket performance is in the mixing of the primary and secondary flows with minimal loss (entropy rise or total pressure loss). An efficient mixing process is essential and requires efficient momentum exchange between the two streams to increase the total

pressure of the secondary flow and to combust the excess fuel in the exhaust. The mixing and pumping characteristics of nozzle afterburning are dependent on geometry design and operating conditions. The actual exit area is an important parameter for controlling inlet-ejector matching. Both mixing and pumping can be altered by the area ratio and shroud L/D (length/diameter). The mixing and pumping characteristics are interdependent; the mixing characteristics cannot be changed without a change occurring in the pumping characteristics.

### **3.2.4 Drag**

To design a viable system, minimizing the overall drag of the system, including ram-drag and external/internal aerodynamic drag must be considered. It is obvious that thrust augmentation could only be realized if the static pressure of the burned mixture exceeds the ambient pressure.

### **3.2.5 Boundary Layer Effects**

Boundary layers developed on the rocket nozzle wall and secondary air induction system will affect the system's pumping capability, momentum exchange between the two streams, and total pressure of mixed region. Flow separation due to adverse pressure gradient in the boundary layer and shock/boundary layer interaction will influence ejector flow and performance. Therefore, in the design process the effects of the boundary layer and the possibility of a boundary layer bleed system needs to be considered.

### **3.2.6 Ejector Weight**

The ejector performance level is a strong function of shroud length. The longer the length of the ejector the more complete will be the mixing (of the primary and secondary flows), pumping, and combustion, but this will also increase ejector weight and volume. The weight, therefore, has to be traded off against increase in performance (thrust). The experimental results from the Rocket Engine Nozzle Ejector (RENE) study (Ref. 2) indicate that an ejector length equivalent to 1 to 2 times ejector inlet diameter would be adequate for application at flight Mach number of 2.

### **3.2.7 Engine/Vehicle Integration**

Since the performance of an ejector/rocket propulsion system is greatly influenced by the condition of the ingested secondary air flow, the vehicle/engine configuration and geometry are critical factors in providing the proper amount and mixing of the ingested air with rocket engine exhaust flow. In the case where multiple rocket engines are used, it is desirable to use one ejector shroud around the cluster of rocket engines (rather than one ejector for each engine) to reduce ejector length and weight and to increase mixing (Ref. 2). This requires proper integration of the total propulsion system with the vehicle during the initial design.

## **3.3 CURRENT EJECTOR/ROCKET STUDY**

For the present conceptual design study of the air-augmented, ejector/rocket concept, the ALS vehicle and flight trajectory are being used to determine the ejector geometry for the LOX/LH<sub>2</sub>



STME engine. In order to define an ejector geometry envelope suitable for operation over a range of flight Mach numbers from zero to 2.0, optimum, point–design, ejector geometry was determined for static condition and for Mach numbers of 0.45, 0.80, 1.0, and 2.0. These optimum geometries provide maximum thrust augmentation at their respective design flight speed but will result in lower thrust augmentation at other flight speeds. A mission analysis is performed for the point–design ejectors with the ALS vehicle and flight trajectory, and the overall effective thrust increase is traded off with an increase in ejector drag and weight. The best ejector geometry and point design flight speed is one which results in maximum payload increase or gross liftoff weight decrease for the ALS baseline vehicle. Unlike the rocket engine, the ejector thrust depends on altitude and on flight speed; therefore, the initial ALS rocket trajectory must be iterated several times to converge on a better ejector performance match with the air breathing portion of the trajectory in terms of altitude, thrust, and flight Mach number.

The present study is ongoing and preliminary results were obtained for the following ejector configuration designed for  $M_o = 1.0$  and operating from liftoff to  $M_o = 2.0$ :

$$\text{Ejector area ratio, } \left( \frac{A_2}{A_s} \right) = 1.60$$

$$\text{Length/diameter ratio, (L/D)} = 1.0$$

$$\text{Inlet area, (A}_s\text{)} = 80 \text{ ft}^2$$

$$\text{Mass flow ratio, } \left( \frac{\dot{m}_s}{\dot{m}_p} \right) = 3.0$$

$$\text{Point design } M_o \cong 1.0$$

For the above ejector design, the thrust augmentation obtained with the STME engine was 12% at sea level static condition, 18% at approximately  $M_o = 1.0$  and 8% at flight  $M_o = 2.0$ . This increased performance, if applied to the propulsion system for the ALS baseline vehicle (which has a payload of 120,000 lb), is equivalent to increasing its payload capability by 16.6% or to decreasing its gross liftoff weight by 9.6% for the same payload. Based on present sensitivity factors developed for the ALS baseline vehicle ( $\Delta PL/\Delta I_s \cong 800 \text{ lb/s}$ ) the 16.6% increase in payload capability is equivalent to an increase in engine specific impulse performance of as much as  $\Delta I_s = 24$  seconds. Further ejector design and trajectory optimization studies will be made during the follow–on Option I Phase of the OEPSS study. The Studies will also include the effect of fuel addition to increase net thrust augmentation.

D600-0011/moh



## APPENDIX A

### TYPICAL MAIN PROPULSION GROUND CHECK-OUT OPERATIONS

1. Aft Closeout Inspection
2. Anti-Slam Check Out
3. Borescope Inspections
4. Cap/Plug Installation Verification
5. Capacitance Test
6. Caution and Warning Verification
7. Command Redundancy Tests
8. Command Verification
9. Copper Path Verification
10. Component Internal Inspections
11. Control/Displays Verification
12. Controller Memory Verification
13. Digital Command I/F Verification
14. Digital Data Word Verification
15. Disconnect Alignment/Rotation Verification
16. Disconnect Cleaning
17. Dry Spin Test
18. Dryness Verification
19. Electrical Bonding Test
20. Electrical Verification
21. Engine/MPS Alignment
22. External Cleaning
23. External Leak Test
24. Filter Inspection
25. Fuel Duct Alignment
26. Gas Sampling
27. Gimbal Angulation Check
28. Gimbal Clearance Check (Engine/Vehicle, Engine/Engine)
29. GSE Removal Verification
30. Heater Test
31. Humidity Indicator Inspection
32. Impeller Lock Verification
33. Install Covers - Lines, Nozzle, Disc, etc...
34. Instrumentation Verification
35. Internal Cleaning/Purging
36. Internal Leak Test
37. Isolation Tests
38. Latch Bi-Stable Check
39. Liquid Level Sensor Resistance Verification
40. Manifold Safing and Blanket Pressurization
41. MCC Liner Polishing
42. MCC to Nozzle Seal Leak Tests
43. Memory(Dump/Compare) Verification
44. Moisture Verification
45. Orifice inspection
46. Power On Verification
47. Power Source Verification
48. Pressure Control Simulations
49. Pressure Decay Test
50. Proof Tests
51. Propellant system Drying
52. Pump Response Time Test
53. Pump Spin Test
54. Purge
55. Regulator Functional Tests
56. Relief System Tests
57. Screen Inspection
58. Sensor Dry Condition
59. Sensor open Condition
60. Sensor Verification
61. Sensor Wet Condition
62. Shaft Travel
63. System Flow Tests
64. Torque Test
65. Transducer Accuracy Test
66. Turbine Bearing Drying
67. Vacuum Jacketed Line Re-evacuation
68. Vacuum Jacketed Line Verification
69. Valve Calibrations
70. Valve Current Signature Tests
71. Valve Functional Verification
72. Valve Response Tests
73. Valve/Switch Configuration Verification
74. Visual Component/Line/Insulation Inspections
75. Voltage Levels
76. XRAY Inspection